



2N[®] IP Vario

Door Entry IP Intercom



Installation Manual

Version: 2.15

www.2n.cz

The 2N TELEKOMUNIKACE a.s. is a Czech manufacturer and supplier of telecommunications equipment.



The product family developed by 2N TELEKOMUNIKACE a.s. includes GSM gateways, private branch exchanges (PBX), and door and lift communicators. 2N TELEKOMUNIKACE a.s. has been ranked among the Czech top companies for years and represented a symbol of stability and prosperity on the telecommunications market for almost two decades. At present, we export our products into over 120 countries worldwide and have exclusive distributors on all continents.



2N[®] is a registered trademark of 2N TELEKOMUNIKACE a.s. Any product and/or other names mentioned herein are registered trademarks and/or trademarks or brands protected by law.



2N TELEKOMUNIKACE a.s. administers the FAQ database to help you quickly find information and to answer your questions about 2N products and services. On www.faq.2n.cz you can find information regarding products adjustment and instructions for optimum use and procedures „What to do if...“.



2N TELEKOMUNIKACE a.s. hereby declares that the 2N product complies with all basic requirements and other relevant provisions of the 1999/5/EC directive. For the full wording of the Declaration of Conformity see the CD-ROM (if enclosed) or our website at www.2n.cz.



This device complies with part 15 of the FCC Rules. Operation is subject to the following two conditions: (1) This device may not cause harmful interference, and (2) this device must accept any interference received, including interference that may cause undesired operation.



The 2N TELEKOMUNIKACE a.s. is the holder of the ISO 9001:2009 certificate. All development, production and distribution processes of the company are managed by this standard and guarantee a high quality, technical level and professional aspect of all our products.

Content:

- 1. Product Overview
 - 1.1 Components and Associated Products
 - 1.2 Terms and Symbols
- 2. Description and Installation
 - 2.1 Before You Start
 - 2.2 Mechanical Installation
 - 2.3 Electric Installation
 - 2.3.1 Overvoltage Protection
 - 2.4 Completion
 - 2.5 Extending Module Connection
- 3. Function and Use
 - 3.1 Configuration
 - 3.2 Intercom Control as Viewed by External User
 - 3.3 Display-Equipped Intercom as Viewed by External User
 - 3.4 Intercom Control as Viewed by Internal User
 - 3.5 Maintenance
 - 3.6 Downloads
- 4. Technical Parameters
 - 4.1 General drawings
- 5. Supplementary Information
 - 5.1 Troubleshooting
 - 5.2 Directives, Laws and Regulations
 - 5.3 General Instructions and Cautions

1. Product Overview

Here is what you can find in this section:

- 1.1 Components and Associated Products
- 1.2 Terms and Symbols

Basic Features

2N[®] IP Vario is a highly reliable IP door access intercom provided with a lot of useful above-standard functions. Supporting the SIP standard and being compatible with the leading IP PBX and telephone suppliers, **2N[®] IP Vario** can make use of all VoIP services.

2N[®] IP Vario can be equipped with a colour camera, which displays the calling person on the called party's video telephone or PC monitor.

2N[®] IP Vario can be provided with up to 54 pre-programmed buttons. You can set up to three telephone numbers and time profiles for each of the buttons to increase the accessibility of the called party.

2N[®] IP Vario can be equipped with a numerical keypad to be used as a code lock for lock switch activating or telephone/subscriber number dialling.

2N[®] IP Vario is equipped with an electric lock switch. You can control the switch using a numerical keypad or, during a call, using any telephone set. An additional switch module can be installed if necessary. A wide range of settings allow for a variety of applications.

2N[®] IP Vario can also be provided with RFID card reader modules.

2N[®] IP Vario is very easy to install. All you have to do is connect the system into your LAN via a network cable and feed it from a 12 V power supply or your PoE supporting LAN.



Configure **2N[®] IP Vario** using your PC via any web browser. Use the **2N[®] Access Commader** to manage extensive **2N[®] IP Vario** systems easily and quickly.

Advantages of Use

- Bidirectional communication – acoustic echo cancelling
- Integrated colour camera
- Optional dial buttons including name tags with backlight
- Optional numerical keypad with backlight
- Integrated electronic lock switches with wide setting options
- Optional integrated RFID card reader module
- LAN (PoE) or external 12 V power supply
- Configuration via web interface or dedicated PC application
- SIP 2.0 support
- Up to 54 buttons pre-programmed buttons
- Up to 1999 telephone directory positions
- Up to 20 user time profiles
- Video codecs (H.263, H.263+, H.264, MPEG-4, JPEG)
- Audio codecs (G.711, G.729, G.722, L16/16 kHz)
- HTTP server for configuration
- SNTP client for time synchronisation with server
- RTSP server for video streaming
- SMTP client for e-mail sending
- TFTP client for automatic configuration and firmware update

1.1 Components and Associated Products

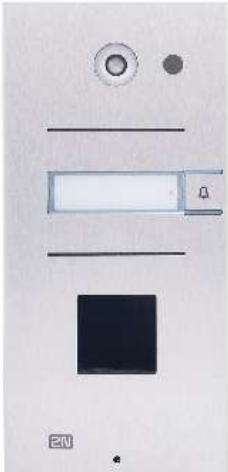
Basic Units

<p>2N Part No. 9137111(C)U Axis Part No. 01306-001, 01313-001 (C)</p> 	<ul style="list-style-type: none">• 1 button• control of one electric lock• possibility of connecting card reader, extenders or information panel or additional switch• available option with camera (C)
<p>2N Part No. 9137131(C)U Axis Part No. 01307-001, 01314-001 (C)</p> 	<ul style="list-style-type: none">• 3 buttons• control of one electric lock• possibility of connecting card reader, extenders or information panel or additional switch• available option with camera (C)

2N Part No. 9137161(C)U

Axis Part No. 01308-001,
01315-001 (C)



- 6 buttons
- control of one electric lock
- possibility of connecting card reader, extenders or information panel or additional switch
- available option with camera (C)

2N Part No. 9137111(C)KU

Axis Part No. 01309-001,
01316-001 (C)



- 1 button
- keypad
- control of one electric lock
- possibility of connecting card reader, extenders or information panel or additional switch
- available option with camera (C)

2N Part No. 9137131(C)KU

Axis Part No. 01310-001,
01317-001 (C)



- 3 buttons
- keypad
- control of one electric lock
- possibility of connecting card reader, extenders or information panel or additional switch
- available option with camera (C)

2N Part No. 9137161(C)KU

Axis Part No. 01311-001,
01318-001 (C)



- 6 buttons
- keypad
- control of one electric lock
- possibility of connecting card reader, extenders or information panel or additional switch
- available option with camera (C)

2N Part No. 9137160(C)

KDU

Axis Part No. 01312-001,
01319-001 (C)



- 6 buttons
- graphic display
- keypad
- control of one electric lock
- possibility of connecting card reader, extenders or information panel or additional switch
- available option with camera (C)

(C) = Integrated camera

Extending Modules

2N Part No.
9135181E

Axis Part No.
01320-001



- Extending module
- 8 buttons
- Dimension of the module 100 x 210 x 29 mm

2N Part No.
9135182E

Axis Part No. 01321-
001



- Extending module
- 16 buttons
- Dimension of the module 100 x 210 x 29 mm



2N Part No.
9135310E

Axis Part No. 01322-
001



- Info panel
- Backlit panel without buttons; used for insertion of a telephone directory, company logo, house number, etc.

Extenders

<p>2N Part No. 9135301E Axis Part No. 01329-001</p> 	<ul style="list-style-type: none">• Spare button name plate
<p>2N Part No. 9135311E Axis Part No. 01331-001</p> 	<ul style="list-style-type: none">• Info panel - name plate• Replacing cover for four name tags.• Helps you use a half of the extending module for insertion of a telephone directory, working hours, etc.
<p>2N Part No. 9135302E Axis Part No. 01330-001</p> 	<ul style="list-style-type: none">• Spare double-button name plate

 **Tip**

- All units can be surface mounted without needing any additional accessories.
- To make them even more robust and resistant, use a Vandal Resistant mask.

 **Caution**

- For flush or outdoor mounting you need to use the accessories; see the Mounting Accessories subsection.

Mounting Accessories

2N Part No. 9135331E

Axis Part No. 01323-001



- Surface 1-module roof
- **Dimensions:** (103 x 218 x 60) mm (W x H x D)

2N Part No. 9135351E

Axis Part No. 01325-001



- Wall mounting box with 1-module frame
- **Dimensions:** (125 x 235 x 46) mm (W x H x D)
- **Wall hole:** (110 x 220 x 50) ±5 mm

2N Part No. 9135361E

Axis Part No. 01327-001



- Wall mounting box with 1-module roof
- **Roof dimensions:** (129 x 240 x 41) mm (W x H x D)
- **Wall hole:** (110 x 220 x 50) ±5 mm

2N Part No. 9135332E

Axis Part No. 01324-001



- **Part No. 9135332E**
- Surface 2-module roof
- **Dimensions:** (203 x 218 x 60) mm (W x H x D)

2N Part No. 9135352E

Axis Part No. 01326-001

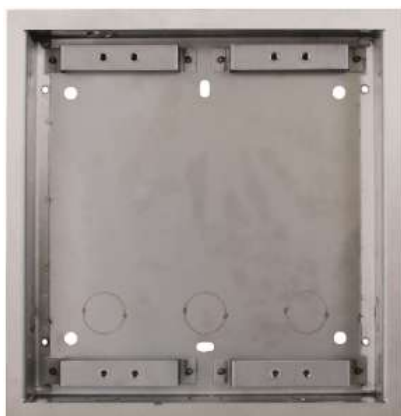

- Wall mounting box with 2-module frame
- **Dimensions:** (225 x 235 x 46) mm (W x H x D)
- **Wall hole:** (210 x 220 x 50) ±5 mm

2N Part No. 9135362E

Axis Part No. 01328-001



- Wall mounting box with 2-module roof
- **Roof dimensions:** (229 x 240 x 41) mm (W x H x D)
- **Wall hole:** (210 x 220 x 50) ±5 mm

The mounting accessories are made of stainless steel. For outdoor applications, the use of the roof is required unless weather protection is provided otherwise. The box with frame (without roof) allows for installation of **2N[®] IP Vario** in indoor applications so that the unit does not practically stick out (up to 1 mm).

Internal Units and Accessories

Part Numbers:

2N Part No. 91378375

Axis Part No. 01668-001

2N Part No. 91378376

Axis Part No. 01670-001



- 2N[®] Indoor Touch 2.0 - black
- WiFi version (second part no.)
- The elegant internal touch panel, 2N[®] Indoor Touch 2.0 , is suitable for all 2N IP intercoms. On the panel's display not only can you find out who is at the door, but also start a conversation with the visitor, open the lock or turn on the light in the entrance hall.

2N Part No. 91378382

Axis Part No. 01425-001



- 2N[®] Indoor Touch desk stand black

Part Numbers:

2N part No. 91378375WH

Axis Part No. 01669-001

2N Part No. 91378376WH

Axis Part No. 01671-001



- 2N[®] Indoor Touch 2.0 - white
- WiFi version (second part no.)
- The elegant internal touch panel, 2N[®] Indoor Touch 2.0, is suitable for all 2N IP intercoms. On the panel's display not only can you find out who is at the door, but also start a conversation with the visitor, open the lock or turn on the light in the entrance hall.

2N Part No. 91378382W

Axis Part No. 01426-001



- 2N[®] Indoor Touch desk stand white

VoIP Telephones

2N Part No. 91378357

Axis Part No. 01422-001



- Grandstream GXV3240 VoIP video telephone
- GXV3240 is the successor to the popular GXV3140 model, which allows comfortable video calls in the IP network. Touchscreen and keypad control.

2N Part No. 91378358



Axis Part No. 01421-001



- Grandstream GXV3275 VoIP telephone
- GXV3275 is the successor to the popular GXV3175 model, which allows comfortable video calls in the IP network. Touchscreen control.

Electric Locks

<p>Part No. 932071E</p> 	<ul style="list-style-type: none">• BEFO 11211• 12 V / 230 mA DC• low consumption
<p>Part No. 932081E</p> 	<ul style="list-style-type: none">• BEFO 11221 with momentum pin• 12 V / 230 mA DC• low consumption• For opening of the lock a short electrical impuls is sufficient, which unlocks the lock. Lock is then open until someone closes the door.
<p>Part No. 932091E</p> 	<ul style="list-style-type: none">• BEFO 11211MB with mechanical blocking• 12 V / 230 mA DC• low consumption• Enables mechanically close or open the lock. When opened, the lock is open all the time. When closed, it behaves as standart electrical lock.

<p>Part No. 932061E</p> 	<ul style="list-style-type: none">• BEFO 211211 door signalling, low consumption• 12 V / 230 mA• A regular lock with a built-in contact to indicate whether the door is open or closed.
<p>Part No. 932072E</p> 	<ul style="list-style-type: none">• BEFO 31211• fail-safe• 12 V / 170 mA DC• The failsafe lock is closed when electricity is switched on. When electricity is interrupted, the lock is opened.
<p>Part No. 932062E</p> 	<ul style="list-style-type: none">• BEFO 321211• fail-safe, door signalling• 12 V / 170 mA• The failsafe lock is closed when electricity is switched on. When electricity is interrupted, the lock is opened.• It contains a built-in contact to indicate whether the door is open or closed.

✔ **Tip**

- FAQ: Electric locks - Difference between locks in 2N IP intercoms accesories

Power Supply

Part Numbers:

2N Part No. 91378100E

2N Part No. 91378100US

Axis Part No. 01403-001



- PoE injector - with EU cable
- PoE injector - with US cable
- For power supply of intercom via ethernet cable when PoE switch is not available.

Part No. 91341481E



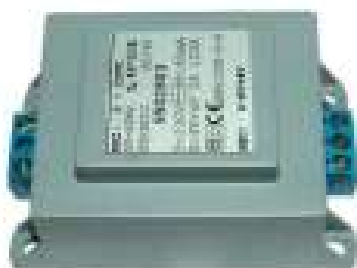

- Stabilised 12 V / 2 A power supply needs to be used when no PoE is available.

Part No. 932928









- 12 V transformer
- For 230 V mains voltage.
- For external power supply of the lock with 12 V AC voltage.

Additional Modules



<p>2N Part No. 9137310E Axis Part No. 01332-001</p> 	<ul style="list-style-type: none">• Enables control of a secondary device, NO/NC passive contacts. Time unlimited switching up to 48 V / 2 A.
<p>2N Part No. 9137430E Axis Part No. 01333-001</p> 	<ul style="list-style-type: none">• Card reader 125 kHz• Internal RFID card reader for installation in the basic module of the 2N[®] IP Vario intercom. Allows the use of EM4100 and EM4102 cards. Another two switches, two logical inputs and a Wiegand interface are available. It is compatible with all 2N[®] IP Vario models.
<p>2N Part No. 9154004 Axis Part No. 01479-001</p> 	<ul style="list-style-type: none">• Water-proof metal button• (suitable for Internal RFID card reader)

<p>2N Part No. 9159010 Axis Part No. 01386-001</p> 	<ul style="list-style-type: none"> • 2N[®] Security Relay • A handy add-on that significantly enhances door entry security as it prevents tampering with the intercom and forced opening of the lock. To be installed between intercom and lock, powered by the intercom.
<p>2N Part No. 9159011 Axis Part No. 01387-001</p> 	<ul style="list-style-type: none"> • Wiegand Isolator • The 2N[®] Wiegand Isolator is designed for galvanic isolation of two devices separately power supplied and interconnected via the Wiegand bus. The 2N[®] Wiegand Isolator protects the interconnected devices against communication errors and/or damage.
<p>2N Part No. 9137410E Axis Part No. 01397-001</p> 	<ul style="list-style-type: none"> • External IP Relay - 1 output • Standalone IP device which can be controlled by HTTP commands sent by 2N IP intercom, which can thus control devices on unlimited distance.

<p>2N Part No. 9137411E</p> <p>Axis Part No. 01398-001</p> 	<ul style="list-style-type: none">• External IP Relay - 4 outputs, PoE• Standalone IP device which can be controlled by HTTP commands sent by 2N IP intercom, which can thus control devices on unlimited distance.
<p>2N Part No. 9134165E</p> <p>Axis Part No. 01395-001</p> 	<ul style="list-style-type: none">• RFID card, type EM4100, 125 kHz
<p>2N Part No. 9134166E</p> <p>Axis Part No. 01396-001</p> 	<ul style="list-style-type: none">• RFID fob, type EM4100, 125 kHz

<p>Part No. 9159013</p> 	<ul style="list-style-type: none"> • Exit button • (suitable for Internal RFID card reader or Security relay) • A button for connection to a logic input for opening a door inside a building.
<p>2N Part No. 9159012 Axis Part No. 01388-001</p> 	<ul style="list-style-type: none"> • Magnetic door contact • (suitable for Internal RFID card reader)
<p>Part No. 9159014EU/UK Part No. 9159014US Axis Part No. 01404-001</p> 	<ul style="list-style-type: none"> • 2N[®] 2Wire • (set of 2 adaptors and power source for EU/US/UK) • The 2N[®] 2Wire converter allows you to use existing wiring (2 wires) from your original door bell or door intercom to connect any IP device. You don't have to configure anything, and you only need one 2N[®] 2Wire unit at each end of the cable and a power source connected to at least one of these units. <p>The 2N[®] 2Wire unit then provides PoE power not only to the second converter, but also to all other connected IP end devices.</p>

<p>2N Part No. 9159030 Axis Part No. 01389-001</p> 	<ul style="list-style-type: none"> • External 125 kHz RFID card reader • Secondary reader for connection to an internal reader. Allows control of card entry from both sides of the door. IP67 cover, also suitable for exteriors. Reads EM4100 and EM4102 cards.
<p>2N Part No. 9159031 Axis Part No. 01390-001</p> 	<ul style="list-style-type: none"> • External 13.56 MHz Mifare RFID card reader, Wiegand • Secondary reader for connection to an internal reader. Allows control of card entry from both sides of the door. IP68 cover, also suitable for exteriors. Reads Mifare cards.
<p>2N Part No. 9137420E Axis Part No. 01399-001</p> 	<ul style="list-style-type: none"> • USB RFID card reader 125 kHz • External RFID card reader for connection to a PC using a USB interface. Suitable for system management and the addition of EM41xx cards via the PC application, 2N[®] Access Commander.

<p>2N Part No. 9137421E Axis Part No. 01400-001</p> 	<ul style="list-style-type: none"> • Ext. RFID Reader 13.56 MHz, 125 kHz + NFC/HCE (USB interface) • External RFID card reader for connection to PC using a USB interface. Suitable for system administration and adding 13.56 MHz, 125 kHz cards and Android platform devices supporting NFC/HCE using 2N IP intercom web interface or the 2N[®] Access Commander application. It reads the same types of cards and devices as card readers in 2N IP intercoms. <ul style="list-style-type: none"> • <u>13.56 MHz/ISO/IEC 14443A</u> Mifare Classic 1k & 4k, DESFire EV1, Mini, Plus S&X, Ultralight, Ultralight C • <u>13.56 MHz/ISO/IEC 14443B</u> CEPAS, HID iCLASS (CSN only) • <u>13.56 MHz/JIS X 6319</u> Felica • <u>ISO/IEC 18092</u> SmartPhone with NFC/HCE support, since Android version 4.3 (2N[®] Mobile Key app required) • EMarine
<p>2N Part No. 9159050 Axis Part No. 01391-001</p> 	<ul style="list-style-type: none"> • 2N[®] Induction Loop • An induction loop transmits sound wirelessly from the 2N IP intercom to the earphones of people with hearing disabilities and enables them to hear and perceive sounds better.

<p>2N Part No. 9159052 Axis Part No. 01393-001</p> 	<ul style="list-style-type: none">• Power supply for 2N[®] Induction Loop• External power supply for the induction loop.• Input 230 V AC• Output 12 V DC
<p>2N Part No. 9159051 Axis Part No. 01392-001</p> 	<ul style="list-style-type: none">• 2N[®] Induction loop - external antenna• External antenna boosts the range of usability of the induction loop, so that the disabled user can receive the audio signal in wider area. Use an external antenna with the induction loop, Part No. 9159050. A 170 cm long interconnecting cable is included.
<p>2N Part No. 916020 Axis Part No. 01371-001</p> 	<ul style="list-style-type: none">• RJ-45 adapter

2N Part No. 9160501

Axis Part No. 0820-001



- AXIS A9188 Network I/O relay module
- Lift control relay module for up to 8 floors

License

2N Part No. 9137905 Axis Part No. 01376-001	<ul style="list-style-type: none">• Enhanced Audio
2N Part No. 9137906 Axis Part No. 01377-001	<ul style="list-style-type: none">• Enhanced Video
2N Part No. 9137907 Axis Part No. 01378-001	<ul style="list-style-type: none">• Enhanced Integration
2N Part No. 9137908 Axis Part No. 01379-001	<ul style="list-style-type: none">• Enhanced Security
2N Part No. 9137909 Axis Part No. 01380-001	<ul style="list-style-type: none">• Gold
2N Part No. 9137910 Axis Part No. 01381-001	<ul style="list-style-type: none">• InformaCast
2N Part No. 9137915 Axis Part No. 01382-001	<ul style="list-style-type: none">• NFC

2N Part No. 9137916 Axis Part No. 02001-001	<ul style="list-style-type: none">• Lift Module
--	---

✔ **Tip**

- Refer to the Configuration Manual for 2N IP intercoms, Subs. **3.2 Function Licensing** for details.

✔ **Tip**

- For more accessories and particular advice please contact your local distributor of 2N products.

1.2 Terms and Symbols

The following symbols and pictograms are used in the manual:

Safety

- Always abide by this information to prevent persons from injury.

Warning

- Always abide by this information to prevent damage to the device.

Caution

- Important information for system functionality.

Tip

- Useful information for quick and efficient functionality.

Note

- Routines or advice for efficient use of the device.

2. Description and Installation

Here is what you can find in this section:

- 2.1 Before You Start
- 2.2 Mechanical Installation
- 2.3 Electric Installation
- 2.4 Completion
- 2.5 Extending Module Connection

2.1 Before You Start

Product Completeness Check

Before you start please check whether the contents of the package of your new 2N[®] IP Vario complies with the following list.



- 1x 2N[®] IP Vario
- 1x spare seal
- 1x drilling template
- 1x hexagonal wrench
- 1x spare name plate
- 1x terminal block plug
- 2x screw
- 2x dowel
- 1x brief manual
- 1x Certificate of ownership

2.2 Mechanical Installation

Overview of Installation Types

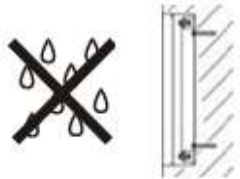
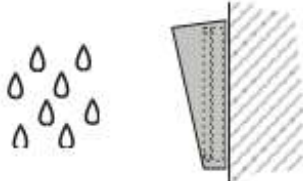
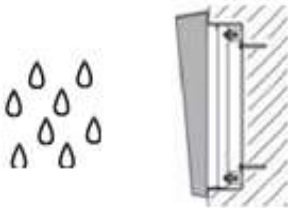
An overview of the installation types and the list of the required components are provided in the table below.

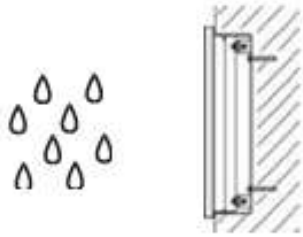
Installation type	Symbol	What you need for installation
Indoor, on surface		<ul style="list-style-type: none"> • 2N[®] IP Vario only
Indoor, flush mounting		<ul style="list-style-type: none"> • 2N[®] IP Vario • Box with 1-module frame 9135351E or Box with 2-module frame 9135352E
Outdoor, on surface		<ul style="list-style-type: none"> • 2N[®] IP Vario • Surface 1-module roof 9135331E or Surface 2-module roof 9135332E
Outdoor, flush mounting		<ul style="list-style-type: none"> • 2N[®] IP Vario • Wall mounting box with 1-module roof 9135361E or Wall mounting box with 2-module roof 9135362E

Installation type	Symbol	What you need for installation
With increased resistance		<ul style="list-style-type: none"> • 2N[®] IP Vario • Vandal resistant mask with box, version according to the assembly
Indoor application means		<ul style="list-style-type: none"> • Indoor areas with a low relative air humidity value (e.g., hallways, offices and other heated rooms). • Indoor areas where humidity condenses on walls but never flows down the walls (porches, storage areas, industrial areas, e.g.). • Outdoor areas where protection against rain and water flowing down the wall is provided (sheds, passages. e.g.).
Outdoor application means		<ul style="list-style-type: none"> • Environments where the product is exposed to rain or where water may flow down the walls (fence, outer wall of a building, e.g.).

 **Caution**

- Before starting the mechanical installation on a selected place, make sure carefully that the preparations connected with it (drilling, wall cutting) cannot damage the electrical, gas, water and other existing wires and pipes.
- The warranty does not apply to the product defects and failures arisen as a result of improper mounting (in contradiction herewith). The manufacturer is neither liable for damage caused by theft within an area that is accessible after the attached electric lock is switched. The product is not designed as a burglar protection device except when used in combination with a standard lock, which has the security function.
- When the proper mounting instructions are not met, water might get in and destroy the electronics. It is because the intercom circuits are under continuous voltage and water infiltration causes an electro-chemical reaction. The manufacturer's warranty shall be void for products damaged in this way!

Surface Mounting

1. Drill holes according to the template included in the 2N[®] IP Vario supply. Insert the included dowels in the wall holes.

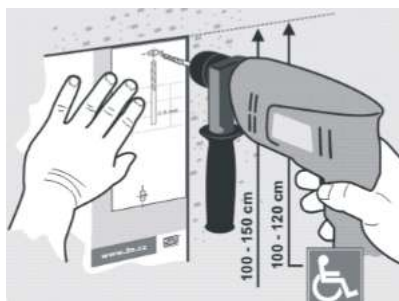

2. Use the hexagon key wrench included in the supply and remove the 2N[®] IP Vario metal cover. Remove the screw in the lower part of the metal cover and fold out the cover.

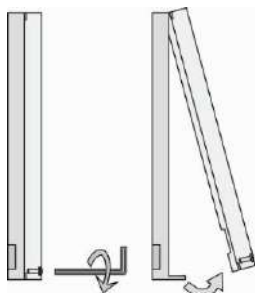

3. Use a cross-head screwdriver to remove the plastic cover and demount the cover.

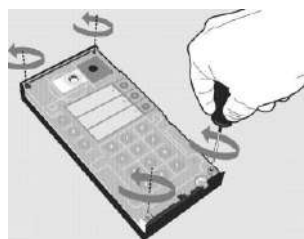

Warning

- Never remove the main board or camera electronics from under the lower cover while installing **2N[®] IP Vario**. Do not disconnect the camera flat cable from the main board. Do not bend and press upon the flat cable either.

4. In multiple-module assemblies connect the boxes, placing the basic module to the left and the extending modules to the right. The interconnecting cable shall be connected later!

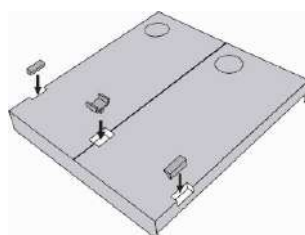

5. Install blank modules on the unused side holes as shown in Figure previous step.

6. If you are installing a roof module, put it on the wall now.

7. Fix **2N[®] IP Vario** on the wall with screws. Carry the supply cables (Ethernet, lock, power cables) to the basic module box through one of the holes. Seal the screw hole carefully with some cement or non-aggressive silicone to avoid water infiltration.

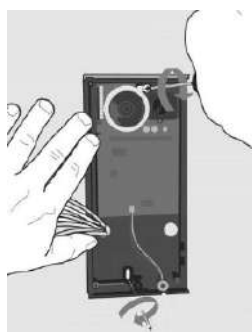

Warning

- Make sure that the mounting surface for the 2N[®] IP Vario door communicator is perfectly flat. Avoid mechanical overload upon the bottom part of the cover. An incorrect installation on an uneven surface may lead to cover deformation and thus product malfunctions.

8. While installing a roof module, paste its top and side edges to the wall using silicone glue to prevent water from flowing into the box along or around the cables.

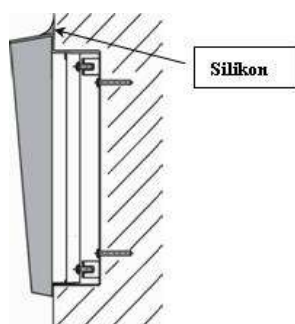

9. Connect the cables as described in subsection 2.4, Mounting – Electrical Installation. Make sure that the cables are not squeezed while installing the plastic cover. For the correct cable installation.

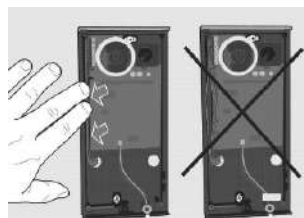

10. Remove the protective foil from the display (for display-equipped 2N[®] IP Vario versions only).

11. Make sure that the cables are placed properly inside and that none of them obstructs a perfect cover closure.

12. Make sure that the three loudspeaker holder feet fit into the board holes. Keep the required loudspeaker position to make the seal work properly.

13. Having mounted the unit on the wall and connected all cables, replace the plastic cover using cross-recessed screws.

Warning

- Remember to tighten all the four corner screws to fix the loudspeaker seal after electric installation to avoid water in-leak! A **PZ1** cross-head screwdriver is recommended.

14. Take out the name plates from the plastic cover. Use a flat-bladed screwdriver, for example.

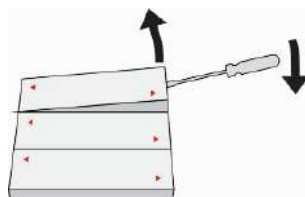

15. Remove the inserts from the name plates.

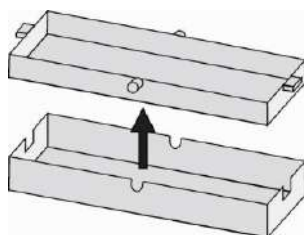

16. Insert the printed foil labels.

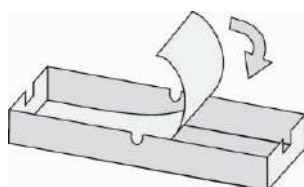

17. Put the inserts back in the name plates.

18. Replace the name plates, clicking them into position. The name plates hold the matt foil inserted underneath.

19. Check whether a silicone seal is inserted in the top groove of the plastic cover. A spare seal package is included.

20. Close the metal cover and fix it with screws.

Outdoor Installation Rules

- Always connect button backlighting – it is used for heating.
- The joint between the roof module and the wall must be filled with a waterproof cement to prevent water in-leak (see Figure 2.5).
- Water must not leak in along or around the cables.

Warning

- Make sure that all the holes are filled with a waterproof material – top, around the cables and screws – and that a side sealing is ensured.

Name Tag Material and Printing

Each 2N[®] IP Vario package includes a sheet of transparent foil for laser printing. Cut the printed foil into pieces and insert the labels in the name plates. Do not use paper to avoid water in-leak and paper damage.

Red arrows are printed on the name plate. Make sure that the text and the arrow do not overlap. We recommend you to use a template (MS Word) available in section Downloads for printing.

Flush Mounting

Follow the installation instructions included in the flush mounting box delivery.

Caution

- The warranty shall not apply to product failures and defects caused by improper installation (contrary to these instructions). The manufacturer is neither liable for damages caused by theft within an area that is accessible after the attached electric lock is switched. The product is not designed as a burglar protection device except when used in combination with a standard lock, which has the security function.

2.3 Electric Installation

- Description of Printed Circuit Board Connectors
- Terminal Block X2 Connection
- Ethernet Connection
- Electric Lock Connection
- External Power Supply Connection
- Configuration Connector Connection
- Display Connector
- Card Reader Connection
- Grounding
- Available switches

2N[®] IP Vario is designed for connection in the Ethernet computer network (10/100BASE-T) using a UTP cable. Use a CAT 5e UTP cable at least for connection.

Caution

- The device must be part of the electrical system of the building.

2N[®] IP Vario is fed through the PoE (Power over Ethernet) technology. No additional cabling is therefore necessary. If your Ethernet is not equipped with the PoE technology, it is possible to use a PoE injector, Part No. 91378100. As an alternative, you can use a power adapter, Part No. 91341481E. 2N[®] IP Vario is configured over an integrated administration web server, which can be controlled from any web browser, e.g., Mozilla Firefox.

Tip

- Video Tutorial: **Door communication system 2N[®] IP Vario - Electrical Installation.**

Description of Printed Circuit Board Connectors

In figure below you can see the location of the printed circuit board (PCB) connectors. Connectors to which the accessories can be connected and connectors that serve for configuring 2N[®] IP Vario are indicated on the board. The UTP cable for the Ethernet connection is to be connected to the terminal block X2 as shown in table below. The terminal block can be removed from the PCB. The connection of each of the connectors is described in the subsections below.

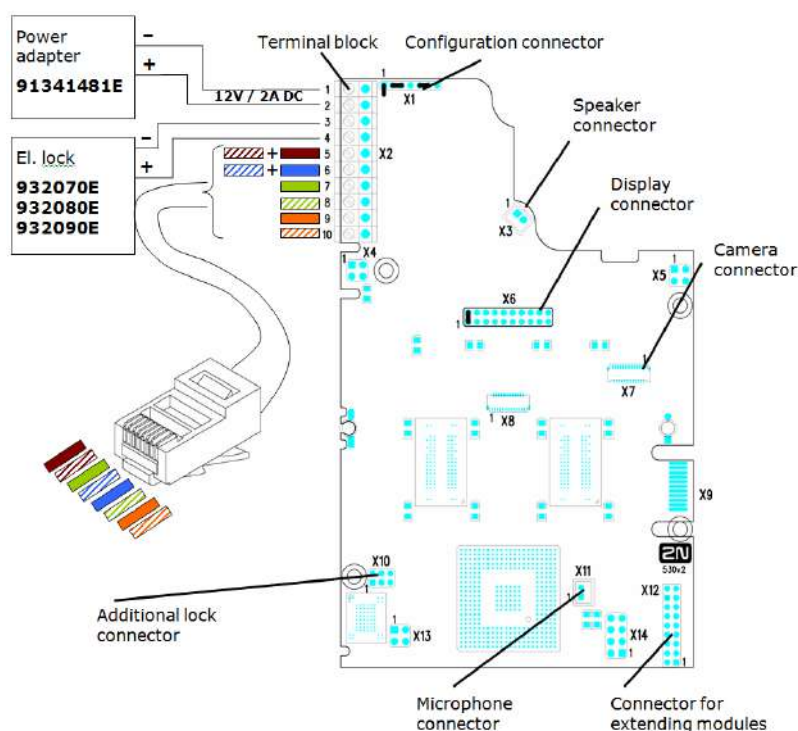

Description of Connectors, PCB Version 530v2

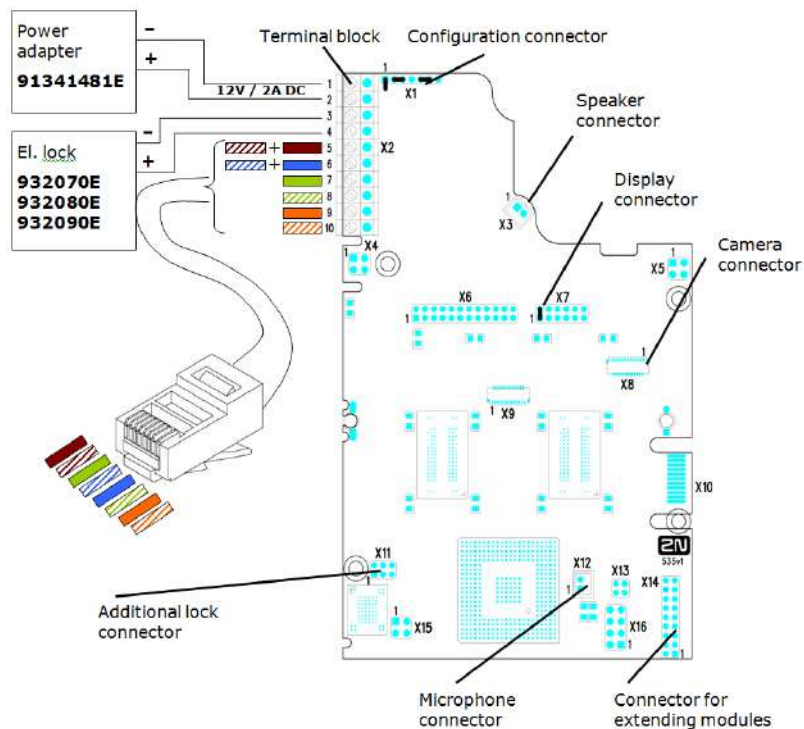

Description of Connectors, PCB Versions 535v1, 535v2

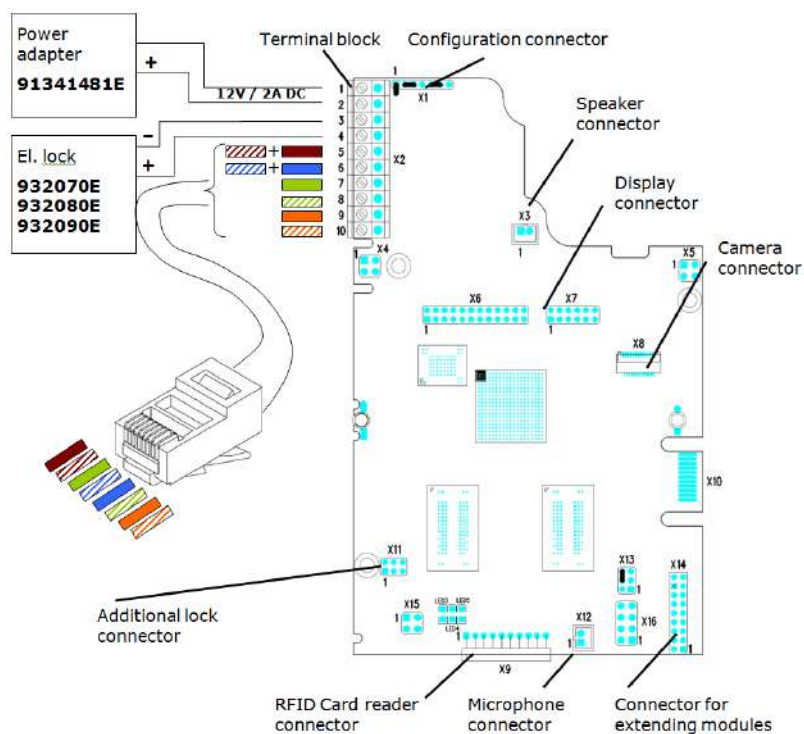

Description of Connectors, PCB Versions 535v5

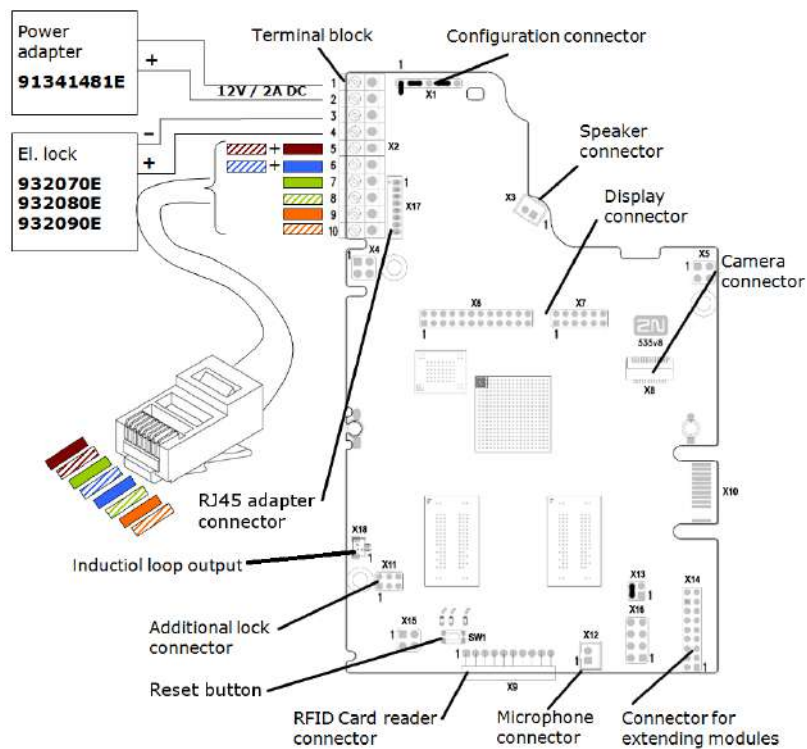

Description of Connectors, PCB Versions 535v8

✓ **Tip**

- Output wiring diagram for Relay terminals

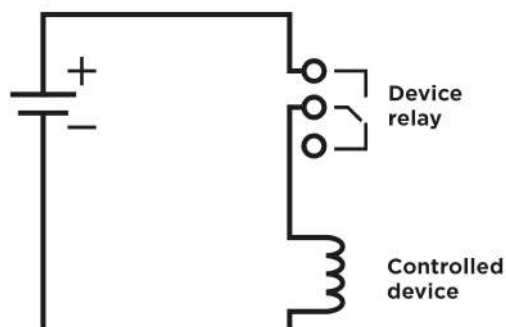

Wiring diagram for the controlled device's electric circuit closing

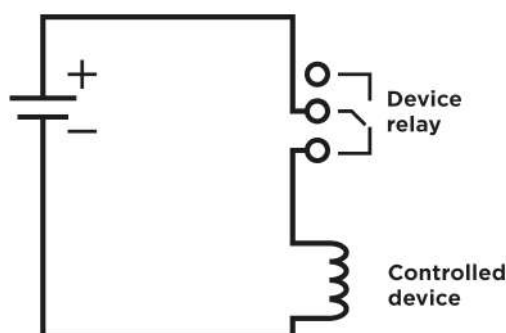

Wiring diagram for the controlled device's electric circuit opening

Terminal Block X2 Connection

Terminal block X2 includes 10 terminals whose functions are distinguished by colour.

Terminals 5-10 are used for connecting 2N[®] IP Vario to the Ethernet. Terminals 3-4 are designed for connecting the electric lock and terminals 1-2 help connect an external 12 V / 2 A DC power supply if no PoE power supply is available.

1. The terminal block is included in the package. To adjust an already installed 2N[®] IP Vario, disconnect it IP from the power supply. Then pull to remove the terminal block from the printed circuit board.
2. Insert the wires under the respective terminals.
3. Tighten the terminals using a flat screwdriver.
4. Replace the terminal block to the printed circuit board.

⚠ Caution

- Make sure that the cables leading through the 2N[®] IP Vario cover bottom groove are installed properly. For the correct installation of the cables refer to Figure 2.7.

Induction loop connection

The JST SHR-02V-S connector type is required to connect the induction loop output.

Ethernet Connection

For the connections and meanings of the wires see the table below. Join UTP cable wires 4 (blue) and 5 (white-blue) and attach them under terminal 6 on 2N[®] IP Vario in the same way. Join wires 7 and 8 and place them under terminal 5 of 2N[®] IP Vario.

RJ-45		2N [®] Helios IP Vario			
	Pin No.	Marking	Colour	Terminal No.	
	1	Tx+		10	
	2	Tx -		9	
	3	Rx+		8	
	4	PoE -		6	
	5	PoE -		6	
	6	Rx -		7	
	7	PoE +		5	
	8	PoE +		5	



Terminal Block Connections

 **Caution**

- We recommend the use of a LAN surge protection.
- We recommend the use of a shielded SSTP Ethernet cable.

Electric Lock Connection

The electric lock can be connected to terminals 3 and 4 of terminal block X2.

Electric lock	2N® Helios IP Vario		
	Marking	Colour	Terminal No
 932070E 932080E 932090E	-		3
	+		4

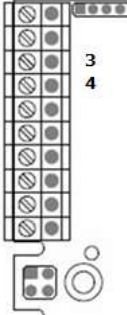

Terminal Block Connection for Electric Lock

Terminals 3 and 4 are connected to a relay on the 2N® IP Vario board. The relay terminals may act as normally open or normally closed contacts. Configuration is performed through the configuration connector X1 as described in the

Configuration Connector Connection subsection. Set on the configuration connector whether the electric lock will be powered from an external or internal power supply.

⚠ Warning

When you connect a device containing a coil, such as a relay or an electromagnetic lock, it is necessary to protect the intercom against voltage peak while switching off the induction load. For this way of protection, we recommend a 1 A / 1000 V diode (e.g., 1N4007, 1N5407, 1N5408) connected antiparallel to the device.

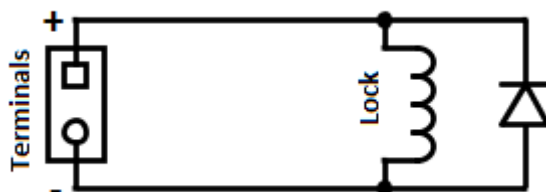



External Power Supply Connection

If the Ethernet network is not equipped with the PoE technology, you have two alternative options how to supply power to 2N[®] IP Vario.

1. Using a PoE injector, Part No. 91378100. 2N[®] IP Vario is then powered through an Ethernet cable as shown in Tab. 1 above.
2. Using a power adapter, Part No. 91341481E.

The external power supply from a power adapter can be connected to terminals 1 and 2.

Power supply	2N [®] Helios IP Vario			
	Marking	Marking	Terminal No.	
 91341481E	-	█	1	
	+	█	2	

Terminal Block Connection for Power Adapter

Configuration Connector Connection

The configuration connector is located in the upper part of the printed circuit board. Use the configuration jumpers to set whether the lock control relay should have a normally open or normally closed function and whether it should be powered internally or externally.

Lock power supply		Relay		Configuration connector
Internal	External	Normally closed	Normally open	Connection of jumpers
✓		✓		
	✓	✓		
✓			✓	
	✓		✓	

Connection of Configuration Connector Jumpers

Display Connector

The display connector includes the name plate backlighting ON/OFF switching pins and 2N[®] IP Vario resetting pins. The remaining pins are intended for display connection.

Resetting procedure (version 535v5 and earlier)

1. Switch 2N[®] IP Vario off.
2. Connect the jumper into the resetting (default setting) position (put the display switch into the F_RES position in the display-equipped models with 535v1 and 535v2 board versions).
3. Switch 2N[®] IP Vario on and wait for the acoustic start signal.
4. Switch 2N[®] IP Vario off.
5. Remove the jumper from the resetting (default setting) position (put the display switch into the NORMAL position in the display-equipped models with 535v1 and 535v2 board versions).
6. Switch 2N[®] IP Vario on.

Normal operation	Default settings	Display connector X6 PCB version 530v2	Display connector X7 PCB version 535v1, 535v2	Connector X13 PCB version 535v5

Configuration Jumpers on Display Connector

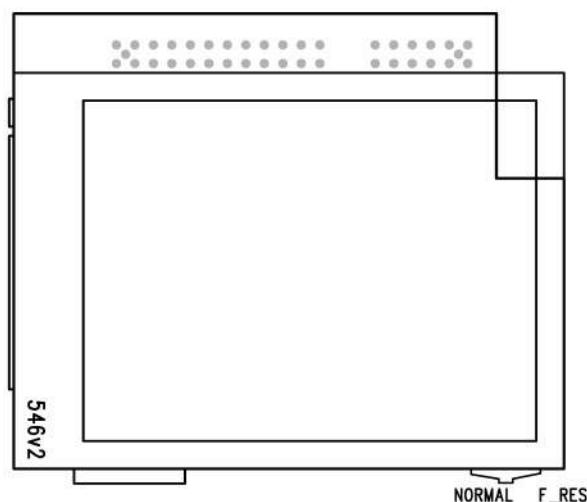

Resetting Procedure – Display Model (models with 535v1 and 535v2 board versions)

To reset the default values of a display-equipped **2N[®] IP Vario**, put the switch in the display right-hand bottom corner in position F_RES. This applies to modules with board versions 535v1 and 535v2 only. For 535v5 versions, use a jumper at connector X13.

Reset Button

Located among the main unit connectors, the Reset button helps you reset the factory default values, restart the device, find the device IP address and switch the static /dynamic mode.

IP Address Finding

Follow the instructions below to **identify the current IP address**:

- Press and hold the RESET button.
- Wait until the red and green LEDs go on simultaneously on the device and the acoustic signal  can be heard (approx. 15–35 s).
- Release the RESET button.
- The device automatically announces the current IP address.

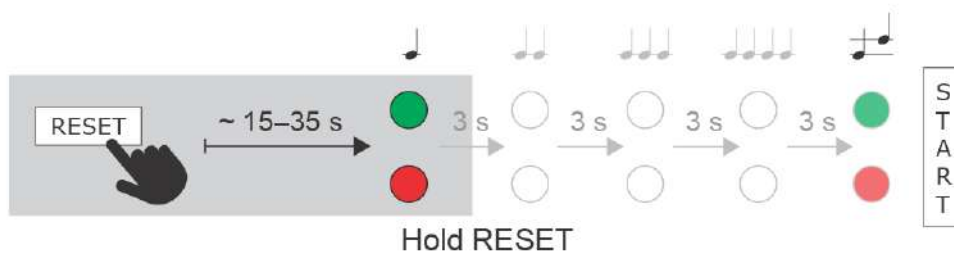



Note

- The delay after pressing RESET till the first light and sound signalling is set to 15-35 s depending on the 2N IP intercom/answering unit model used.
 - 24 s is the valid value for 2N[®] IP Vario HW version 8.

Static IP Address Setting

Follow the instructions below to switch on the **Static IP address** mode (DHCP OFF):

- Press and hold the RESET button.
- Wait until the red and green LEDs go on simultaneously on the device and the acoustic signal  can be heard (approx. 15-35 s).
- Wait until the red LED goes off and the acoustic signal  can be heard (approx. for another 3 s).
- Release the RESET button.

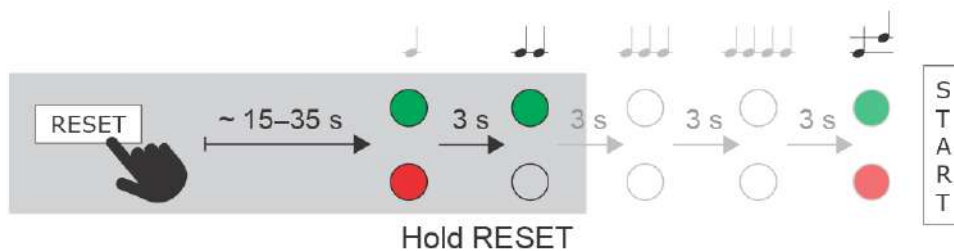

The following network parameters will be set after restart:

- IP address: 192.168.1.100
- Network mask: 255.255.255.0
- Default gateway: 192.168.1.1



Dynamic IP Address Setting

Follow the instructions below to switch on the **Dynamic IP address** mode (DCHP ON):

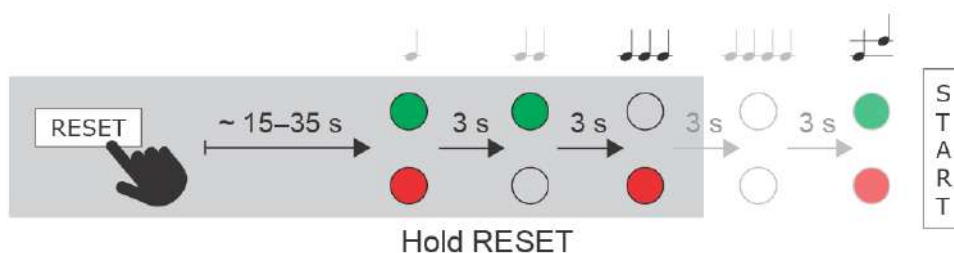

- Press and hold the RESET button.
- Wait until the red and green LEDs go on simultaneously on the device and the acoustic signal  can be heard (approx. 15–35 s).
- Wait until the red LED goes off and the acoustic signal  can be heard (approx. for another 3 s).
- Wait until the green LED goes off and the red LED goes on again and the acoustic signal  can be heard (approx. for another 3 s).
- Release the RESET button.



Factory Reset (version 535v8 and later)

Follow the instructions below to **reset the factory default values**:

- Press and hold the RESET button.
- Wait until the red and green LEDs go on simultaneously and the acoustic signal  can be heard (approx. 15–35 s).

- Wait until the red LED goes off and the acoustic signal  can be heard (approx. for another 3 s).
- Wait until the green LED goes off and the red LED goes on again and the acoustic signal  can be heard (approx. for another 3 s).
- Wait until the red LED goes off and the acoustic signal  can be heard (approx. for another 3 s).
- Release the RESET button.

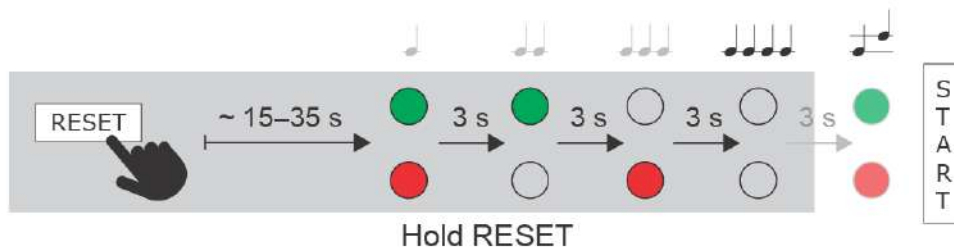

Caution

- In case of resetting the factory default settings on a device with a version of firmware 2.18 or higher it is necessary to reprogram the 2N[®] Security Relay using the instructions from section 2.4.

Device Restart

Press the RESET button shortly (< 1 s) to restart the system without changing configuration.

Note

- The time interval between the short press of RESET and reconnection after restart is 25–50 s for 2N[®] IP Vario depending on the HW version.

Card Reader Connection

2N[®] IP Vario (Part Nos. 91371...U) can be equipped with an internal multifunction module including an RFID card reader (Part No. 9137430E).

This module enhances the 2N[®] IP Vario functions with an EM41XX RFID card reader, two relays for external load switching, two logical inputs and Wiegand interface. The RS-485 interface is not supported in the current 2N[®] IP Vario software version.

Caution

- The 2N[®] IP Vario modules ending with U (i.e. 91371...U) can only be equipped with the card reader.

Card Reader Mounting

1. Power off 2N[®] IP Vario.
2. Use a hexagonal wrench to unscrew and remove the metal cover.
3. Use a cross-head screwdriver to unscrew and remove the plastic cover.
4. Connect the reader module into the 2N[®] IP Vario basic unit bottom connector making sure that the microphone cable lies under the module.
5. Use the enclosed screws to fix the reader module to the 2N[®] IP Vario plastic base.
6. Connect the wires for the reader module interface(s) if necessary.
7. Replace and fix the plastic cover using cross-head screws.
8. Replace and screw back the metal cover.



Grounding

We recommend you to ground the intercom in order to improve the static electricity resistance. All you need for a proper grounding is a cable of the minimum cross-section of 4 mm² and a crimp eye.



Push the nut gently at the marked point to slide it downwards. Insert a sufficiently long M3 screw, e.g. Push the screw down to make a gap for the crimp eye.



Insert the crimped cable at the marked point.



Assemble the set and ground the cable.



Available Switches

Location	Name	Description
Basic Unit	Relay 1	<p>Passive switch: NO and NC contacts, up to 30 V / 1 A AC/DC. Used for connection of non-critical devices only (lights, e.g.).</p> <p>Active switch output: 10 up to 14 V DC depending on power supply (PoE: approx. 14 V; adaptor: same voltage as power supply), max 600 mA</p>
Additional Switch (Part No. 9137310 E)	Relay 2	<p>Passive switch: NO and NC contacts, up to 30 V / 1 A AC/DC. Used for connection of non-critical devices only (lights, e.g.).</p>
Internal RFID Card Reader 125 kHz (Part No. 9137430 E)	Relay 1 (Card Reader)	<p>Passive switch: NO and NC contacts, up to 30 V / 1 A AC/DC</p>
	Relay 2 (Card Reader)	<p>Passive switch: NO and NC contacts, up to 30 V / 1 A AC/DC</p>

2.3.1 Overvoltage Protection

Recommendations for Additional Overvoltage Protection Installation

If running:

- a) outside a building,
- b) on/in an outer wall or roof,

the 2N device wiring may be exposed to atmospheric effects resulting in overvoltage that may subsequently damage any devices installed outside the building, on its outer wall or roof. Overvoltage may damage devices connected to these wires and installed inside the building as well. Therefore, we recommend that additional surge protectors be installed on all the wires leading outside buildings, on outer walls or roofs, namely:

- a) as close as possible to the device installed outside the building or on its outer wall /roof,
- b) as close as possible to the point where the wires leave the building.

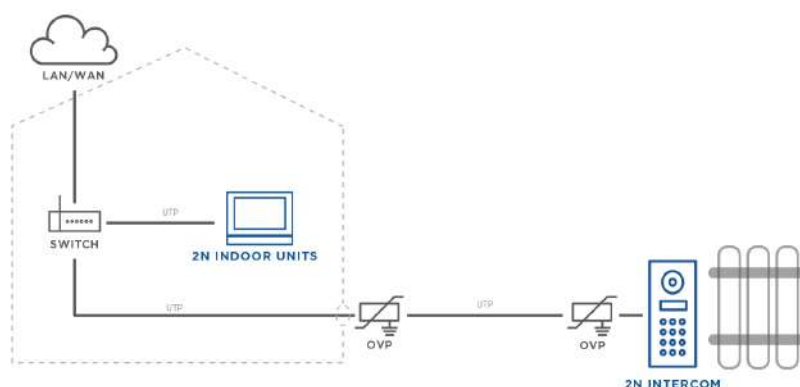
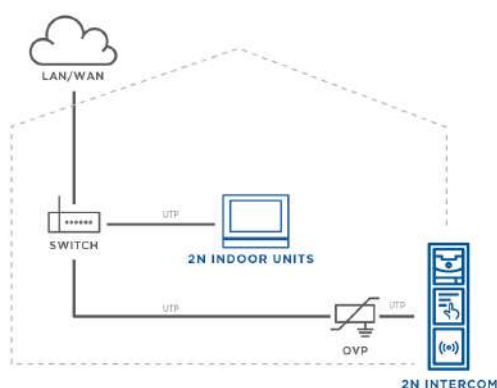

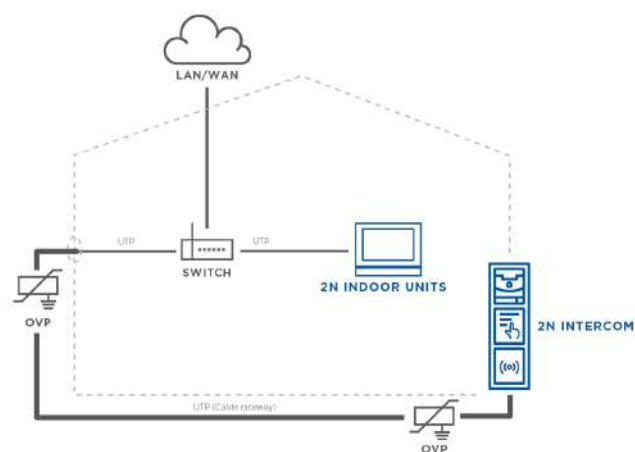

OVP = overvoltage protection

2.4 Completion

1. Remember to seal the 2N[®] IP Vario cable passage hole properly to avoid moisture in-leak and damage to electronics due to condensation.
2. Make sure that the wires inside 2N[®] IP Vario are not squeezed and insert the plastic top cover (a transparent plastic mould) carefully making its contacts plug into the electronics board connectors. Push the plastic cover into position moderately. If the part swings over an obstacle or one corner is higher than the others, remove the cover and find the obstacle. Then tighten the corner screws properly.
3. Mounting the metal sheet cover follow the steps included in the subsection dedicated to name plate removal. Make sure that the cover fits well and is perfectly flat. If its bottom part is loose, the mounting wall is probably uneven. Support the corners to avoid 2N[®] IP Vario bending.



Caution

- An improper mounting may significantly deteriorate the button function.
- A poor outdoor mounting may cause water in-leak and damage to the electronics.

Most Frequent Mounting Errors

For illustration, a part of the plastic cover is removed in the figures below to reveal the sealed loudspeaker and the cover-seal touch point. The cross section plane is marked white for better orientation.

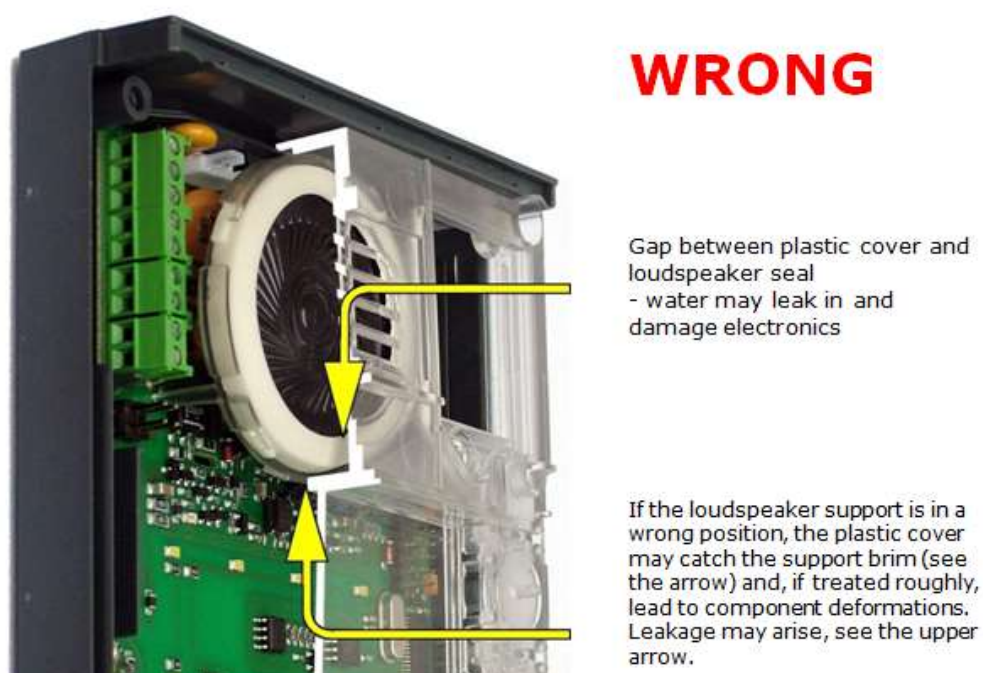
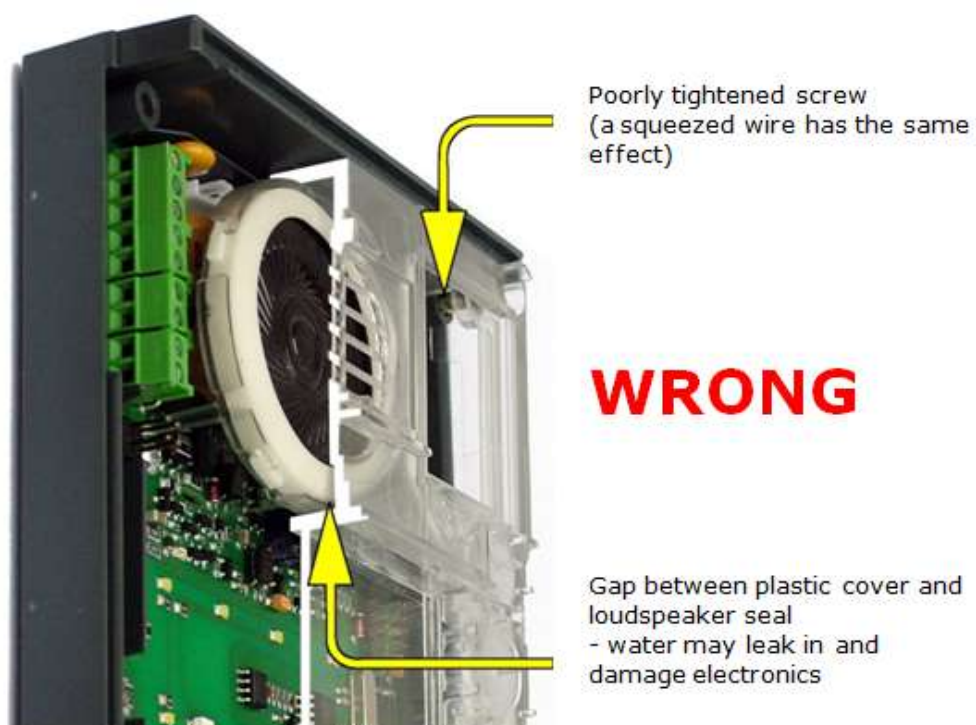

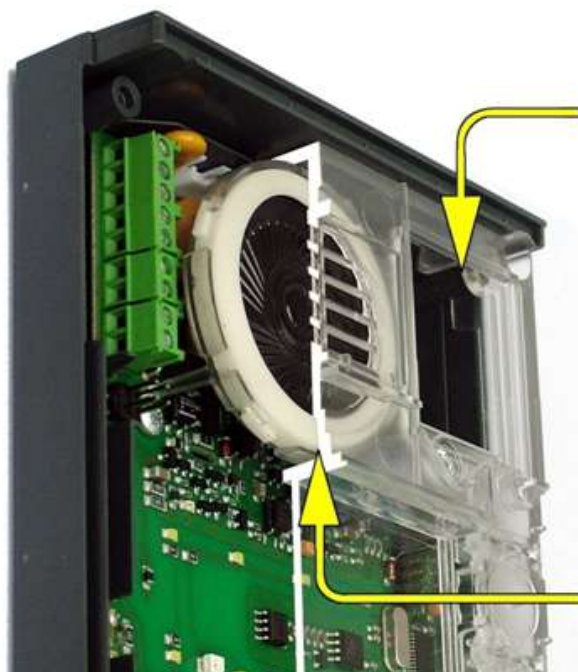

Properly tightened screw

RIGHT

The seal touches the plastic cover. Water flows out through a small hole (not shown in the figure).
Note: Water does not affect the loudspeaker Mylar membrane.

2.5 Extending Module Connection

2N[®] IP Vario allows to connect following extending modules:

- Extending button modules
- Additional Switch
- Internal RFID Card Reader 125 kHz
- Security Relay
- Wiegand Isolator
- Induction Loop

Extending button modules

2N[®] IP Vario features an easy installation of extending button modules. Extending modules are connected using a single cable (included in every extender delivery) in a chain pattern (every additional unit is connected with the previous one). Each extending module has two connectors - an input connector (for connection towards the 2N[®] IP Vario basic unit) and an output connector (for connection of another, more remote unit). Be sure to maintain the correct orientation of the units and avoid connector mismatch to ensure a proper function of the device!

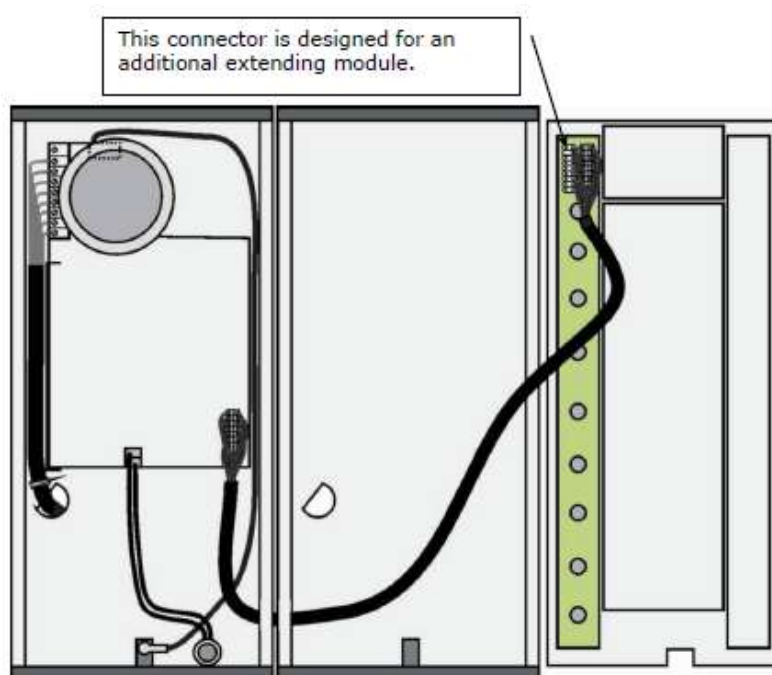

Connection of One-Row-Button Extending Modules

Maximum Count of Extenders

9135181E (1× 8 buttons)	6	5	4	3	2	1	0
9135182E (2× 8 buttons)	0	0	1	1	2	2	3

The table above shows how to combine modules with single (whole) and double buttons.

Module Cable Interconnection

- The cable is included in every extending module delivery. Both its ends are the same. Configuration is 1:1. Connectors cannot be shifted or inserted conversely because they are equipped with a so-called key.
- The basic unit is always on the left. Extenders are chain-connected, i.e. each is linked with its neighbour.
- The cable cannot be driven through the box interconnecting holes until the boxes have been connected (see subsection 2.3 Mounting - Mechanical Installation).

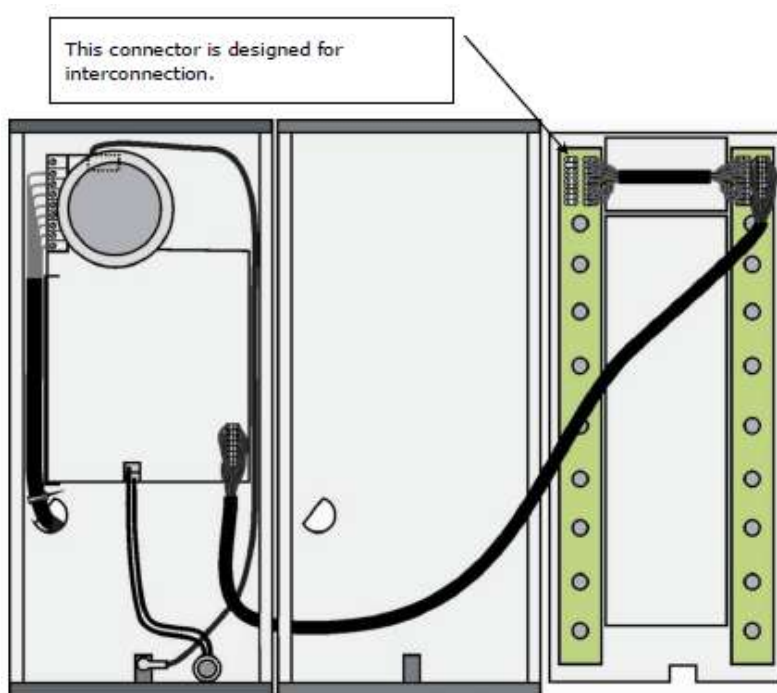

Connection of Two-Button-Row Extending Module

⚠ Caution

- The extending modules must be connected mutually and with the basic unit by means of a formed piece supplied with the extending module!!!

Button Numbering

Button numbering – one-button with a whole-button set

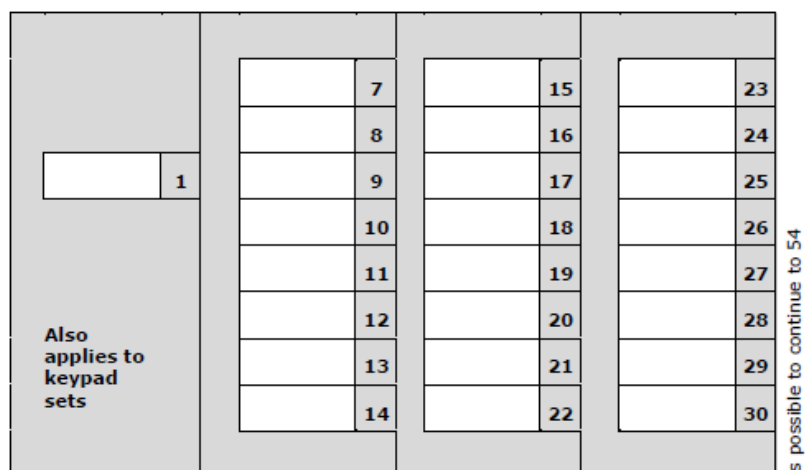

Button numbering – whole-button sets

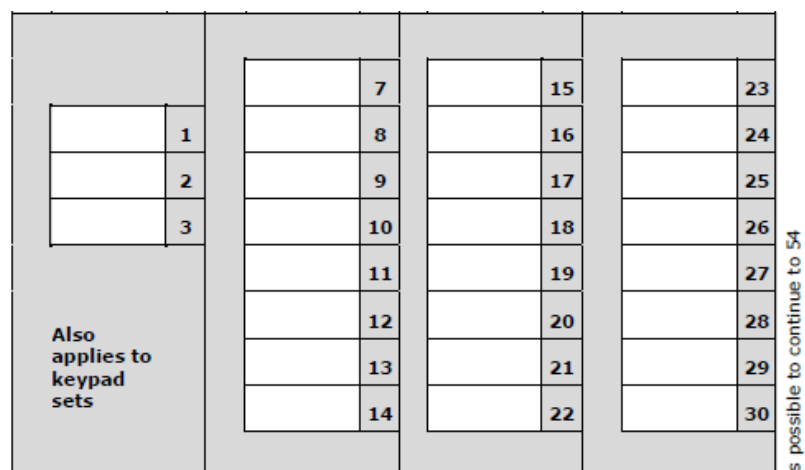

Button numbering - double-button set

			7		15	23		31	39	47
1		4	8		16	24		32	40	48
2		5	9		17	25		33	41	49
3		6	10		18	26		34	42	50
Also applies to keypad sets			11		19	27		35	43	51
			12		20	28		36	44	52
			13		21	29		37	45	53
			14		22	30		38	46	54

Caution

- For the time being, AntiVandal panels are available only for single-button sets with one extending module at most.

Button Numbering - Info Panel Sets

Installing the info panel name plate, Part No. 9135311E, into any of the extending modules will not change the numbering system (the buttons on the info panel sides will remain functional). Connecting the info panel module, Part No. 9135310E, will result in omission of eight numbers.

Additional Switch

The 2N[®] Additional Switch (Part No. 9137310 E) is used to extend the 2N[®] IP Vario door communicator with another switch. 2N[®] Additional Switch is suitable for e.g. electric door lock or low voltage logical inputs of e.g. gate and barrier control systems.



Function:

The 2N[®] IP Vario Additional Switch adds one additional switch to the 2N[®] IP Vario basic unit.

Specifications:

- Passive switch: NO and NC contacts, up to 30 V / 1 A AC/DC

Caution

- Before installing the module, make sure that the current and voltage limits of the module will not be exceeded in your application (refer to the Technical Parameters chapter). **In no case use this module for mains voltage switching!**

Module mounting:

Switch off the intercom before module installation.



Module settings:

Refer to the Configuration manual for 2N IP intercoms for details.

Connection:

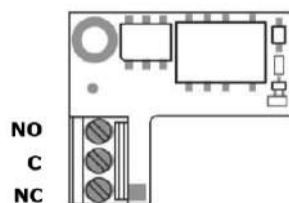

Switch	Connection
Normally opened	NO - C
Normally closed	NC - C

Internal RFID Card Reader 125 kHz

The **Internal RFID Card Reader** (Part No. 9137430 E) is used for reading RFID card IDs in the 125 kHz band. This module is intended for mounting into the **2N[®] IP Vario** model 91371...U.



Function:

The **2N[®] IP Vario** Internal RFID Card Reader adds these features

- RFID card reader
- 2 relay outputs
- 2 digital inputs
- WIEGAND interface
- Signalling outputs (LED / buzzer)

Specifications:

Card reader

- Compatible with EM4100 / EM4102 cards
- Working frequency: 125 KHz
- Minimum reading distance: 10 mm above **2N[®] IP Vario** cover

Relay outputs

- Switching contact
- 30 V / 1 A AC / DC

Logical inputs

Active mode - requires external voltage (JP2 jumper OFF)

- $U_{IN-ON} = \text{min } +2.5 \text{ V}$
- $U_{IN-OFF} = \text{max } +1.5 \text{ V}$
- $U_{IN \text{ max}} = +48 \text{ V}$
- $I_{IN} (U_{IN} +48 \text{ V}) = \text{max } 1 \text{ mA}$

Passive mode - requires external contact only (JP2 jumper ON)

- $U_{OUT} = \text{approx. } 8.3 \text{ V}$
- $I_{LOOP} = \text{approx. } 0.5 \text{ mA}$

Signalling outputs

- 5 V or 12V DC voltage
- 270 ohm current limiter

WIEGAND interface

- Input / Output (as programmed)

Module mounting:

- Power off 2N[®] IP Vario.
- Use a hexagonal wrench to unscrew and remove the metal cover.
- Use a cross-head screwdriver to unscrew and remove the plastic cover.
- Connect the reader module into the 2N[®] IP Vario basic unit bottom connector making sure that the microphone cable lies under the module.
- Use the enclosed screws to fix the reader module to the 2N[®] IP Vario plastic base.
- Connect the wires for the reader module interface(s) if necessary.
- Replace and fix the plastic cover using cross-head screws.
- Replace and screw back the metal cover.

Module settings:

Refer to the Configuration manual for 2N IP intercoms for details.

Connection:

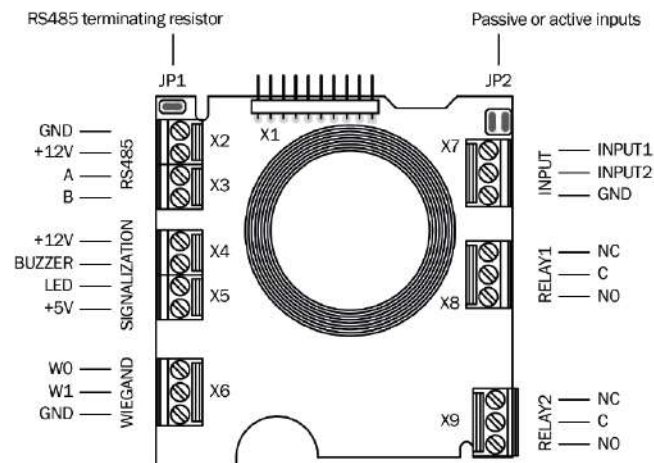

Security Relay

The 2N[®] Security Relay (Part No. 9159010) is used for enhancing security between the intercom and the connected electric lock. The 2N[®] Security Relay is designed for any 2N IP intercom model with firmware versions 1.15 and higher. It significantly enhances security of the connected electric lock as it prevents lock opening by forced intercom tampering.



Function:

The 2N[®] Security Relay is a device installed between an intercom (outside the secured area) and the electric lock (inside the secured area). The 2N[®] Security Relay includes a relay that can only be activated if the valid opening code is received from the intercom.

Specifications:

Passive switch: NO and NC contacts, up to 30 V / 1 A AC/DC

Switched output:

- Where the security relay is fed from the intercom, 9 to 13 V DC is available on the output depending on the power supply (PoE: 9 V; adapter: source voltage of minus 1 V) / 400 mA DC.
- Where the security relay is fed from an external power supply, 12 V / 700 mA DC is available on the output.

Dimensions: (56 x 31 x 24) mm

Weight: 20 g

Installation:

Install the 2N[®] Security Relay onto a two-wire cable between the intercom and the electric lock inside the area to be secured (typically behind the door). The device is powered and controlled via this two-wire cable and so can be added to an existing installation. Thanks to its compact dimensions, the device can be installed into a standard mounting box.

Connection:

Connect the 2N[®] Security Relay to the intercom as follows:

- To the intercom active output (OUT1)

Connect the electric lock to the 2N[®] Security Relay output as follows:

- To the switched output.
- To the passive output in series with the external power supply.

The device also supports a Departure button connected between the 'PB' and '- HeliosIP/IP Intercom' terminals. Press the Departure button to activate the output for 5 seconds.

Status signalling:

Green LED	Red LED	Status
blinking	off	Operational mode
on	off	Activated output
blinking	blinking	Programming mode - waiting for initialisation
on	blinking	Error - wrong code received

Configuration:

- Connect the 2N[®] Security Relay to the properly set intercom switch output; refer to the **Configuration manual for 2N IP intercoms**. Make sure that one LED at least on the 2N[®] Security Relay is on or blinking.
- Press and hold the 2N[®] Security Relay Reset button for 5 seconds to put the device in the programming mode (both the red and green LEDs are blinking).
- Activate the intercom switch using the keypad, telephone, etc. The first code sent from the intercom will be stored in the memory and considered valid. After code initialisation, the 2N[®] IP Security Relay will pass into the operational mode (the green LED is blinking).

Caution

- In case of resetting the factory default settings on a device with a version of firmware 2.18 or higher it is necessary to reprogram the 2N[®] Security Relay using the instructions above.

Tip

- FAQ: 2N[®] Security Relay - what it is and how to use it with 2N IP intercom?

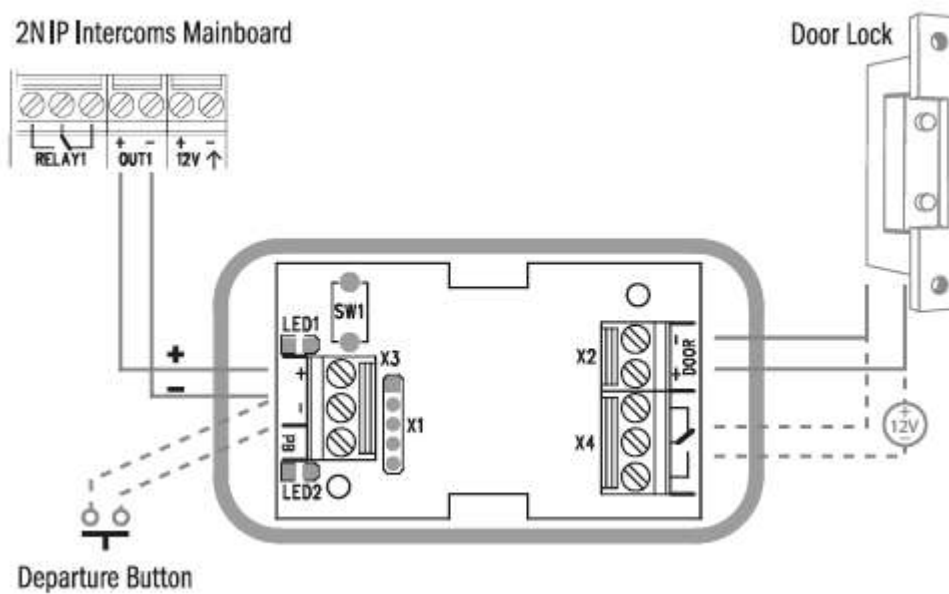
Connection:

Wiegand Isolator

The 2N[®] Wiegand Isolator (Part No. 9159011) is used for galvanic isolation of the Wiegand bus.

The 2N[®] Wiegand Isolator is designed for galvanic isolation of two devices with separate power supply and interconnected via the Wiegand bus.

The 2N[®] Wiegand Isolator protects the interconnected devices against communication errors and/or damage.

Connection of the 2N[®] Card Reader to a security system unit is a typical example of application.



Function:

The 2N[®] Wiegand Isolator separates galvanically a two-wire Wiegand bus in one direction and a status LED signal in the other direction. The module is power supplied from the Wiegand bus receiver side.

Specifications:

- 2-wire WIEGAND IN
- 2-wire WIEGAND OUT
- LED IN switched against GND on WIEGAND OUT side
- Open LED OUT switched against GND on WIEGAND IN side (up to 24 V / 50 mA)
- 5 to 16 V / 10 mA power supply from Wiegand bus receiver side
- 500 V DC isolation strength

Connection:

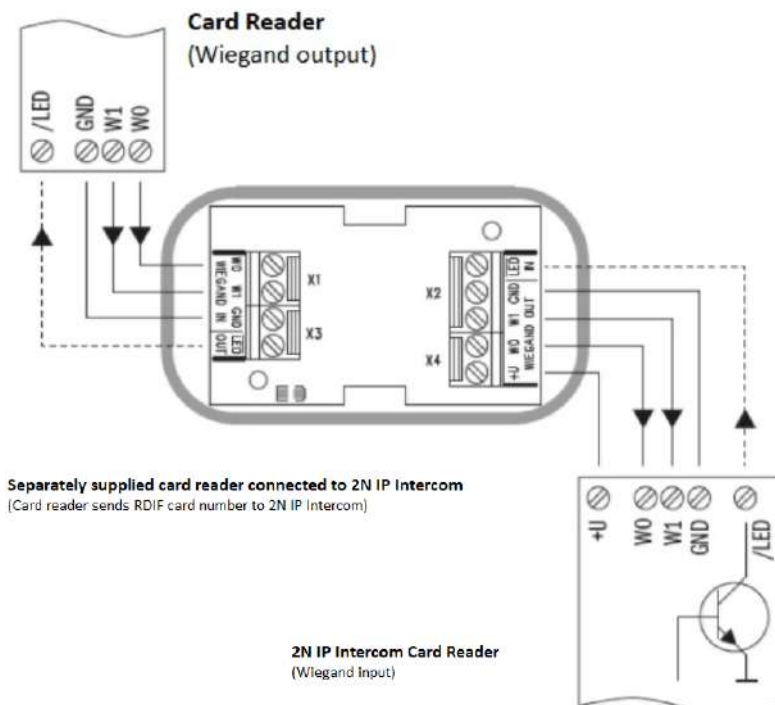
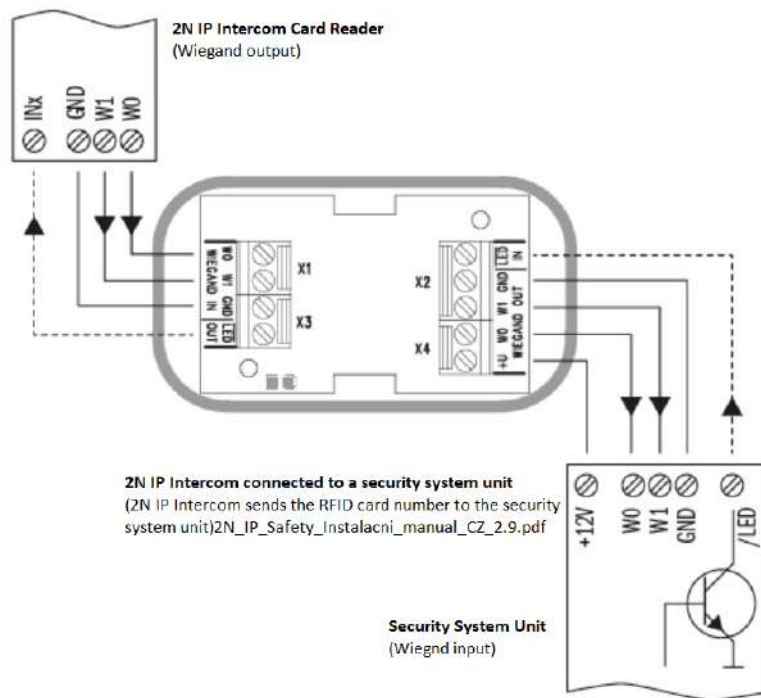

Wiegand Input Technical Parameters	
Current	5 mA
Input resistance	680 Ohm
Pulse length	50 μ s
Delay between pulses	approx. 2 ms

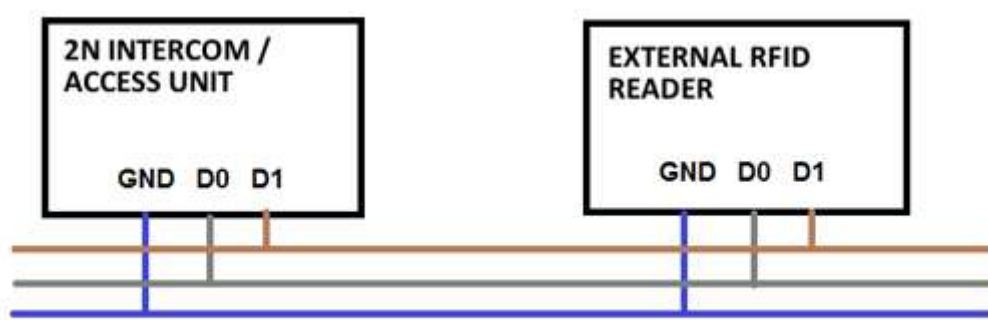

Recommended Wiring Diagram for Reader with Bus Driver

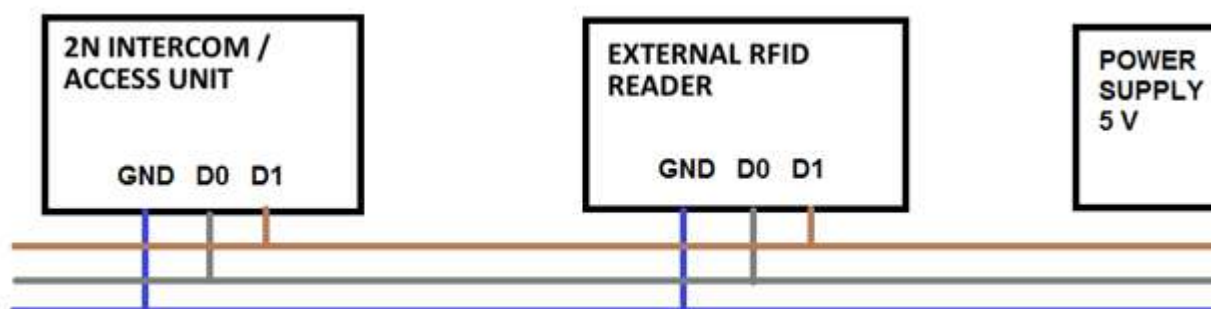

Recommended Wiring Diagram for Reader with Open Collector (OC) Output

Induction Loop

2N[®] Induction Loop (Part No. 9159050 – Induction loop amplifier for **2N IP intercom**, Part No. 9159054 – Induction loop amplifier without 2N IP intercom accessory, Part No. 9159051 – External induction loop for wall mounting, Part No. 9159052 – 12 V DC power adapter) is part of sound system installations for hearing impaired persons that are equipped with a special hearing aid capable of receiving reproduced sound via a magnetic field receiver. The system is defined by the IEC 60118-4 standard.

Installation:

The induction loop amplifier can be wall mounted with the use of an internal induction loop where a signal covering is requested. Outdoor use is possible thanks to the IP65 covering. A four-wire cable of the length of one meter is mounted to the supplied product for easier connection to the intercom. In the cable are two wires for 12 V DC supply and two wires for signal input, the wires are connected into interconnection connector. If you shorten the cable, follow the colour marking.

Before wall mounting run the cable through the hole that you have prepared. Then mark two mounting holes on the wall, through the amplifier front. Remove the amplifier and drill the mounting holes. Use the plugs and screws included in the delivery. Use a drill of the diameter of 6 mm. After fastening, cover the screws with the blanks supplied.

Use the supplied connectors to connect the amplifier to the intercom and power supply. The A connector is connected to the amplifier four-wire cable. Insert a special intercom-connecting cable supplied with the amplifier and 12 V power supply outlets to the B connector. Connect the special cable to the intercom and connect the power supply to the mains. You can place the mated A and B connectors into the **2N IP intercom** cover. The connectors help you connect stripped cables. Open the connector by pushing a thin screwdriver onto the white spots at its front and close the connector by sliding the movable part through a side gap.

Finally, test the amplifier function using a suitable receiver for hearing impaired persons or magnetic field communication tester. No other settings are required.

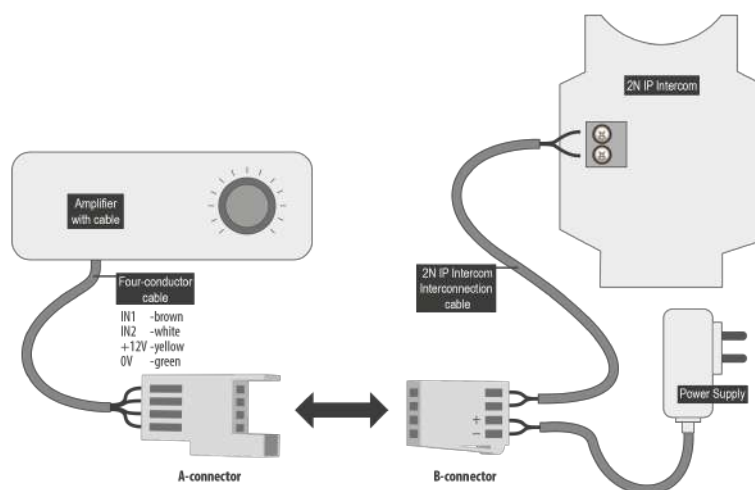

Specifications:

- Supply voltage: 8-18 V DC
- Supply current at 12 V supply:
 - 1 Ω load, full power output; 1.4 A, sine wave signal; 1 A, pink noise signal
 - 8 Ω load, half power output; 550 mA, sine wave signal; 400 mA, pink noise signal
 - standby, up to 10 mA
 - no signal, 100 mA
- Transition to standby w/o signal: 10 s
- Input level - basic: 100 mV - 6 V_{rms}
- Input level - increased: 1 V - 35 V_{rms}
- Input impedance: 2 k Ω parallel with 0.3 H
- Output current, 1 Ω load: 2.2 A_{rms} (sine wave)
- Full power output: 1.6 A_{rms} (pink noise)
- Output current, 8 Ω load: 730 mA_{rms} sine wave signal
- Half power output: 520 mA_{rms} pink noise signal
- Output short-circuit resistance: unlimited time
- Frequency characteristics: 100 Hz - 5 KHz \pm 3 dB
- Temperature range: -20 - +50 °C
- Covering: IP65 (with round cable of 5-10 mm diameter)
- Dimensions: 144 x 100 x 31 mm
- Weight: 0.3 kg

3. Function and Use

This section describes the basic and extending functions of the the 2N[®] IP Vario product.

Here is what you can find in this section:

- **3.1 Configuration**
- **3.2 Intercom Control as Viewed by External User**
- **3.3 Display-Equipped Intercom as Viewed by External User**
- **3.4 Intercom Control as Viewed by Internal User**
- **3.5 Maintenance**
- **3.6 Downloads**

3.1 Configuration

Use a PC equipped with any web browser to configure 2N[®] IP Vario:

- Launch your web browser (Internet Explorer, Firefox, etc.).
- Enter the IP address of your intercom (<http://192.168.1.100/>, e.g.).
- Log in using the **Admin** user name and **2n** password.

You have to know the IP address of your device to log in to the integrated web server.

By default, 2N[®] IP Vario is switched into the dynamic IP address mode, i.e. it obtains the IP address automatically if a properly set DHCP server is available in your LAN. If no such DHCP server is available, you can operate 2N[®] IP Vario in the static IP address mode.

IP Address Retrieval

If your device remains inaccessible (you have forgotten the IP address, or the LAN configuration has changed, for example), change the LAN settings using the buttons on the device.

Take the following steps to retrieve the 2N[®] IP Vario IP address:

- Connect (or, if connected, disconnect and reconnect) 2N[®] IP Vario to the power supply.
- Wait for the second sound signal .
 - 1-button models: Press the quick dial button on the basic unit five times.

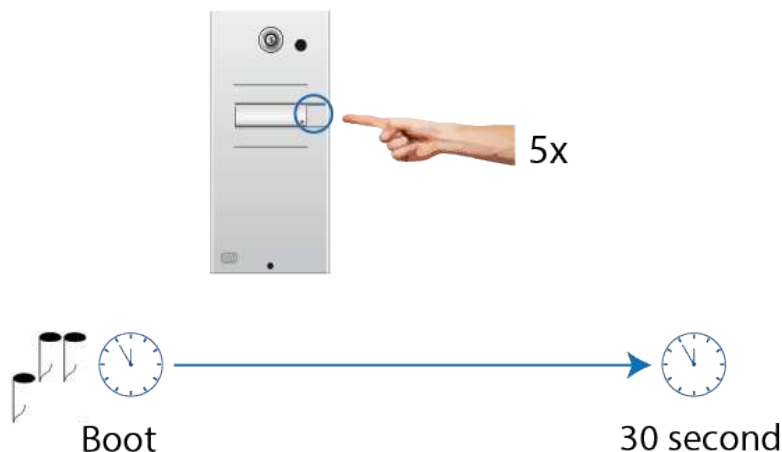

- 3-buttons models: Press the second quick dial button on the basic unit five times.

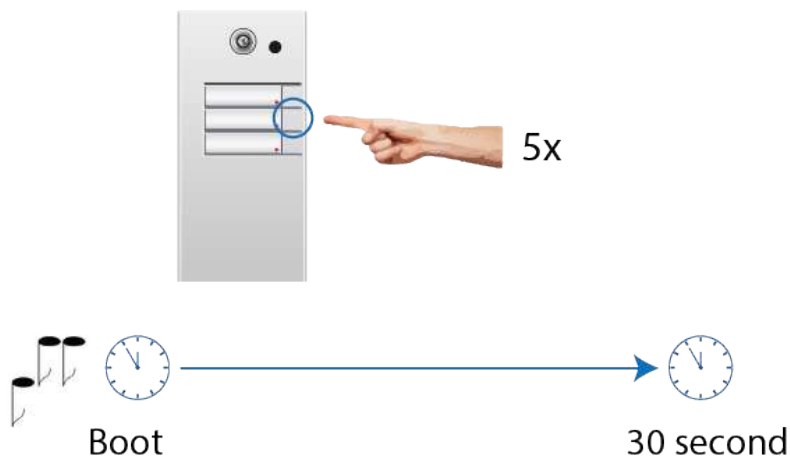

- 6-buttons models: Press the fifth quick dial button on the basic unit five times.
- 2N[®] IP Vario will read its IP address.
- If the address is 0.0.0.0, it means that the intercom has not obtained the IP address from the DHCP server.

Note

- Be sure to press the button sequence within thirty seconds after the sound signal for security reasons. Up to 2 s intervals are allowed between the presses.

Static IP Address Setting

Follow the instructions below to enable the static IP address mode:

- Connect **2N[®] IP Vario** to the power supply (or, disconnect and reconnect it if already connected).
- Wait for the first acoustic signal .
- Press following buttons sequentially:
 - 1, 1, 1, 2, 2, 3 for 3-buttons models

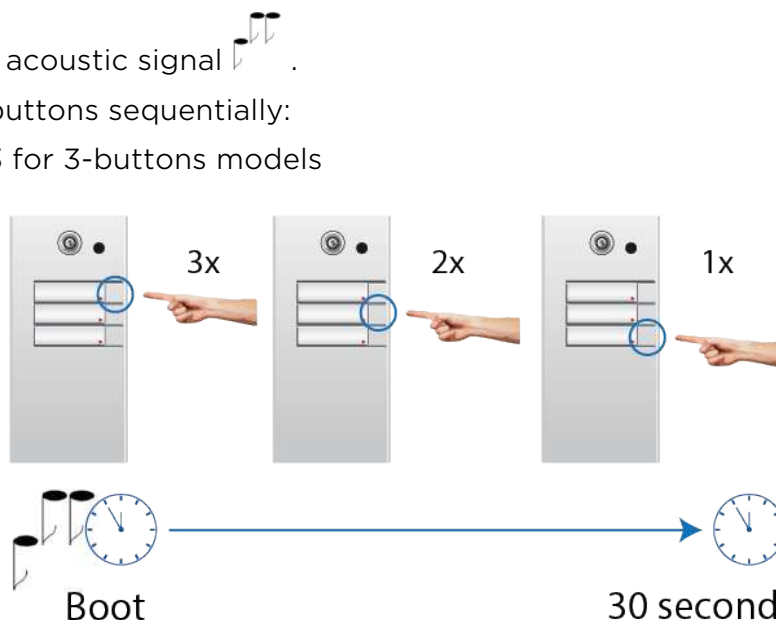

Switching to static IP address

- 4, 4, 4, 5, 5, 6 for 6-buttons models
- The acoustic signal  indicates mode switching.
- Wait until the device is restarted automatically.

Note

- The 1, 1, 1, 2, 2, 3 sequence must be entered within 30 seconds after the first sound signal for security reasons. The inter-digit delay may be 2 s at most.

The device will have the following network parameters after restart:

- IP address - 192.168.1.100
- Network mask - 255.255.255.0
- Default gateway - 192.168.1.1

Dynamic IP Address Setting

Connect 2N[®] IP Vario to the power supply (or, disconnect and reconnect it if already connected). Follow the instructions below to enable automatic getting of network parameters from the DHCP server:

- Wait for the first acoustic signal 
- Press following buttons sequentially:
 - 2, 1, 1, 2, 2, 3 for 3-buttons models

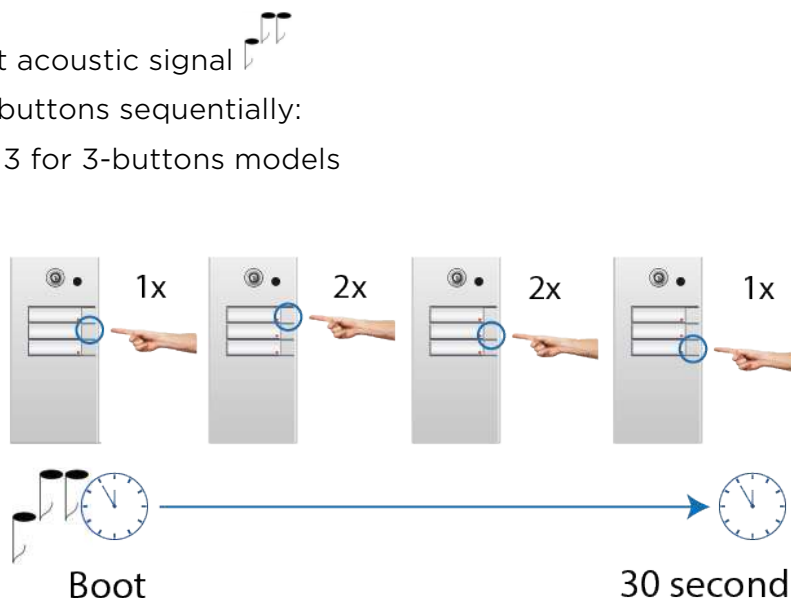

- 5, 4, 4, 5, 5, 6 for 6-buttons modely
- The acoustic signal  indicates mode switching.
- Wait until the device is restarted automatically.



Note

- The 2, 1, 1, 2, 2, 3 sequence must be entered within 30 seconds after the first sound signal for security reasons. The inter-digit delay may be 2 s at most.

2N[®] IP Vario gets the IP address upon restart only if the DHCP server is configured properly.

Mode Switching with 1-Button Models

Connect 2N[®] IP Vario to the power supply (or, disconnect and reconnect it if already connected). In case your 2N[®] IP Vario device is equipped with 1 button, you can switch the modes using one button only.

- Wait for the first acoustic signal .
- Press the quick dial button 15 times.
- The acoustic signal  indicates mode switching.
- Wait until the device is restarted automatically.

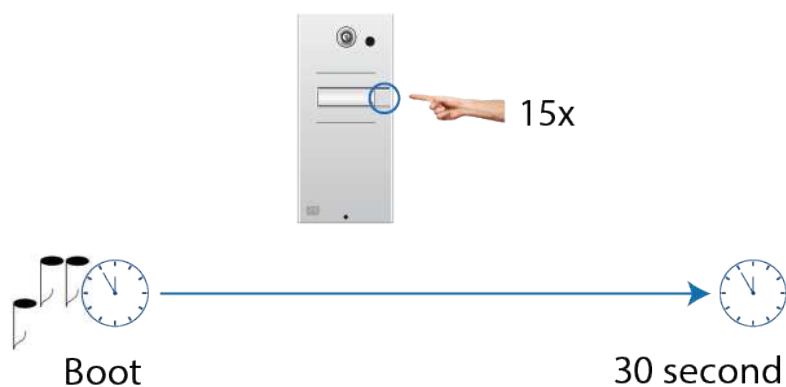

Switching between static and dynamic IP address

Note

- The 15 times 1 sequence must be entered within 30 seconds after the first sound signal for security reasons. The inter-digit delay may be 2 s at most.

The static IP address mode will be switched into the dynamic IP address mode and vice versa upon restart.

3.2 Intercom Control as Viewed by External User

Quick Dialling Buttons

By pushing a quick dialling button on the basic unit you can call to positions 1, 3...6 of the telephone directory (depending on the model type). With extending modules you can use up to 54 quick dialling options.

By pushing a quick dialling button you call the telephone number assigned to the selected telephone directory position. A call set-up is signalled by a long discontinuous tone or any other tone as defined in the attached PBX configuration.



By re-pushing the same button during calling or setting up you can hang up, hang up and call to another telephone number, or activate nothing as defined in the Intercom Configuration / Hardware / Keypad subsection of Configuration Manual.

You can also hang up the call any time by pushing  if the **Hang-up by #** button is enabled; refer to Intercom Configuration / Hardware / Keypad subsection of Configuration Manual.

Calling to Phone Book Position

The 2N[®] IP Vario telephone directory may contain up to 1999 pre-programmed positions. You can use the quick dialling buttons for positions 1 to 54 only. To retrieve the remaining positions, use the numeric keypad if **Dial Users by Phonebook Position** is enabled; refer to the Intercom Configuration / Hardware / Keypad subsection of Configuration Manual.



Procedure:

- Enter the position number using the numeric keypad (e.g. 05, 15, 200, 1759 - two digits at least and four digits at most) and push  for confirmation.
- You can also hang up the call any time by pushing  if the **Hang-up by #** button is enabled; refer to Intercom Configuration / Hardware / Keypad subsection of Configuration Manual.



Calling to User-Defined Telephone Number

If the **Telephone function enable** (refer to the Intercom Configuration / Hardware / Keypad subsection of Configuration Manual) is selected, you can call the user-defined telephone number using the 2N[®] IP Vario numeric keypad.

Procedure:

1. Push .
2. You can hear the continuous tone from the loudspeaker.
3. Enter the telephone number using the numeric keypad and push  again for confirmation.
4. You can also hang up the call any time by pushing  if the **Hang-up by #** button is enabled; refer to the Intercom Configuration / Hardware / Keypad subsection of Configuration Manual.



Incoming Call Answer and Reject

If the automatic incoming call answer is disabled (refer to the Intercom Configuration / Services / Phone / Calls subsection of Configuration Manual), a call coming to 2N[®] IP Vario is signalled with loud ringing. Push  to answer and  to reject the call.

Code Door Opening (Switch Activation)

2N[®] IP Vario is equipped with a door unlocking switch. To activate the switch enter the valid code (refer to the Intercom Configuration / Hardware / Switches subsection of Configuration Manual) on the numeric keypad.





Procedure:

- Enter the lock 1 or lock 2 activating code using the numeric keypad and push .
- A valid code is signalled by a continuous switch activation (lock opening) signalling tone. An invalid code is announced by acoustic signalling .

Profile Activation and Deactivation

You can activate or deactivate a profile and define call routing to the telephone numbers assigned to the profile using the numeric keypad. For more details refer to the Intercom Configuration / Directory / Time Profiles subsection of Configuration Manual subsection.

Procedure:

- Enter the profile activation or deactivation code using the numeric keypad and push  for confirmation.
- A valid code is announced by acoustic signalling  or  depending on the code type. An invalid code is announced by acoustic signalling .

3.3 Display-Equipped Intercom as Viewed by External User

Until the display program is uploaded to 2N[®] IP Vario, the display shows the 2N logo; refer to the figure below. In this state, 2N[®] IP Vario behaves and is controlled like no-display models, see Display-Equipped 2N[®] IP Vario Control as Viewed by External User.

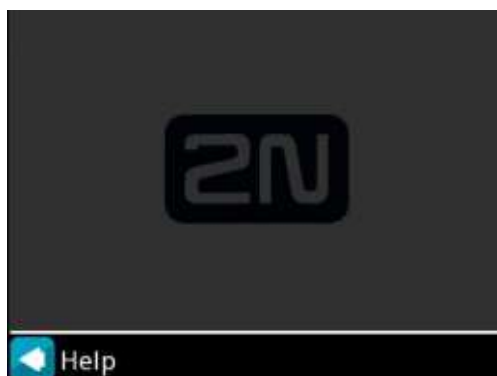

Display with enabled function without configuration

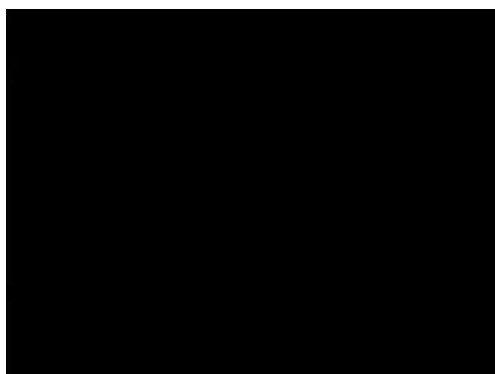

Display with disabled function

With the proper display configuration, the advertisement or electronic name tag mode is displayed upon the 2N[®] IP Vario power on as pre-programmed.

The display-equipped 2N[®] IP Vario model is controlled using the numeric keypad and quick dialling buttons. Buttons 2, 4, 6 and 8 are cursor keys in the telephone directory mode. Buttons 3 and 6 are functional keys and initiate the action displayed in the right-hand and left-hand screen corners.

Advertisement Mode

One or more images defined in the display program are displayed in the advertisement mode. To quit the ad mode and move to the electronic name tag mode, push any quick dialling button or numeric keypad key.

Electronic Name Tags

1, 2 or 4 name tags emulating the paper name tags can be displayed in the electronic name tag mode. Push one of the 1, 2, 4 and 5 quick dialling buttons to call the user assigned.



You can also enter the door lock opening codes and activate or deactivate a user or profile in this mode. For steps refer to the no-display 2N[®] IP Vario subsection. Push the quick dialling button 6 to move to the Telephone directory mode and the  button to move to the **Calling to number** mode (only if the telephone function is enabled, see **Miscellaneous**).

Calling to Number

If the **Telephone function enable** is selected (see **Miscellaneous**), 2N[®] IP Vario can be used for calling to selected telephone numbers in a standard way. Push  in the **Electronic name tag** mode to move to this mode.



Push the quick dialling button 3 or the



button to return to the electronic name tag mode. To dial and display the number to be called, use the numeric keypad and push



for confirmation. Push the quick dialling button 6 to delete and re-enter the last-dialled number if necessary.

Phone Book

A structured phone book as defined by the display program is displayed in the telephone directory mode. To browse through the telephone directory use the numeric keypad arrow keys (i.e. keys 2, 4, 6 and 8). Use the up and down arrows to move between the items. Push the right arrow to establish a call or move to a subgroup. The  key and quick dialling buttons 4 and 5 have the same function as the right arrow. Use the left arrow to return to the superior group.

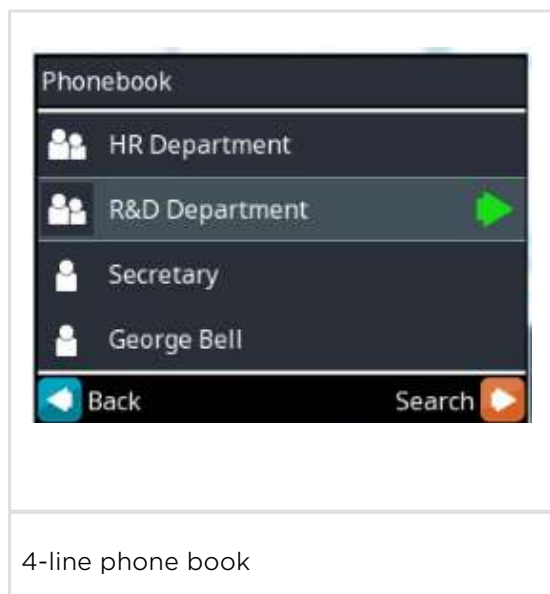

You can also use the telephone directory for retrieving contacts. Push the quick dialling button 6 to switch on the phone directory searching mode.

To retrieve a text, use the numeric keypad. The text to be searched is displayed in the centre of the status line. To delete the last character push the quick dialling button 3.

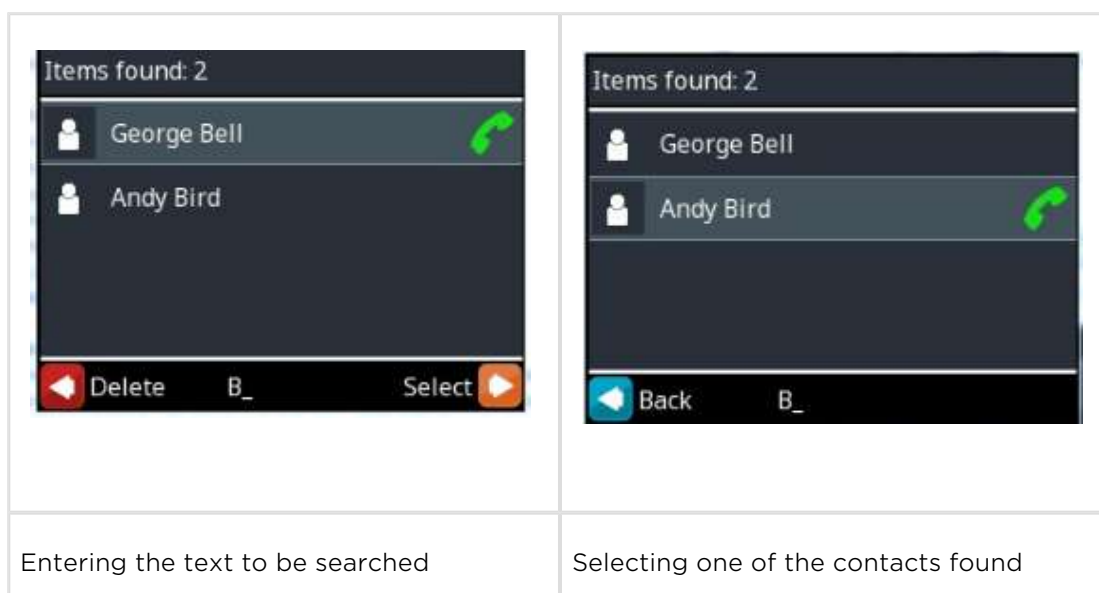







The text string is retrieved on the current level and all sublevels of the telephone directory. The count of contacts found is displayed on the top line. The first 3 (or 4) found contacts are displayed in the central part of the window.

To browse through the contacts found and select the required one, push the quick dialling button 6, thus recovering the arrow function of the numeric keypad.

Status Information

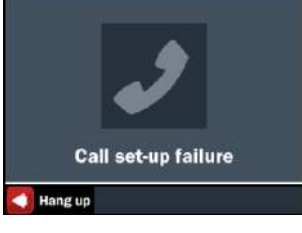
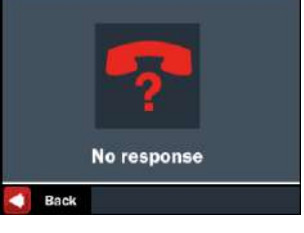
In addition to the above described modes, the 2N[®] IP Vario display indicates various device statuses:

	
Call being set up	Ringing - outgoing call
	
Call connected	Call terminated
	
Call set-up failure	No response

 <p>Incoming call...</p> <p>Back</p>	 <p>Door opened...</p> <p>Back</p>
Incoming call	Door opened/unlocked

3.4 Intercom Control as Viewed by Internal User

Call answering

Incoming calls from 2N[®] IP Vario can be received like any other call. You can open the lock and activate or deactivate a user or profile during the call using your telephone numeric keypad. The call duration is limited to avoid unintentional 2N[®] IP Vario line blocking. Use the Call time limit parameter to set the maximum call duration (refer to the Intercom Configuration / Services / Phone / Calls subsection of Configuration Manual). To prolong a call push the # button on your telephone any time. A short beep 10 s before the call end signals an automatic all termination.



Calling to 2N[®] IP Vario

2N[®] IP Vario allows to answer an incoming call too. To set the required parameters use the Incoming calls item, refer to the Intercom Configuration / Services / Phone / Calls subsection of Configuration Manual.

Code Door Opening (Switch Activation)

2N[®] IP Vario is equipped with a door unlocking switch. To activate the switch enter the valid code (refer to the Intercom Configuration / Hardware / Switches subsection of Configuration Manual) on the numeric keypad.





Procedure:

- Enter the lock 1 or lock 2 activating code using your telephone numeric keypad and push  (confirmation is unnecessary if the Lock code without confirmation option is selected, refer to the Intercom Configuration / Hardware / Switches / Advanced subsection of Configuration Manual).
- A valid code is announced by acoustic signalling . An invalid code is announced by acoustic signalling .

Profile Activation and Deactivation

You can activate or deactivate a profile and define call routing to the telephone numbers assigned to the profile using the numeric keypad. For more details refer to the Intercom Configuration / Directory / Time Profiles subsection of Configuration Manual.

Procedure:

- Enter the profile activation or deactivation code using the numeric keypad and push  for confirmation.
- A valid code is announced by acoustic signalling  or  depending on the code type. An invalid code is announced by acoustic signalling .

3.5 Maintenance

Cleaning

If used frequently, the device surface, the keypad in particular, gets dirty. To clean it, use a piece of soft cloth moistened with clean water. We recommend you to follow these principles while cleaning:

- Never use aggressive detergents (such as abrasives or strong disinfectants).
- Use suitable cleaning agents for glass lens cleaning (cleaners for glasses, optic devices screens, etc.).
- Alcohol-based cleaners may be applied.
- Clean the device in dry weather in order to make waste water evaporate quickly.
- We recommend using cleaning wipes designed for IT / electronic items.

Warning

- Avoid peroxide-based cleaners.

Future Tag Replacement, Programming Changes

For necessary steps refer to the preceding subsections. Keep the following for future changes:

- This manual
- Unused transparent foil strips for button tags

Caution

- Always use the product for the purpose it was designed and manufactured for, in compliance herewith.
- The manufacturer reserves the right to modify the product in order to improve its qualities.
- 2N[®] IP Vario contains no environmentally harmful components. When the product's service life is exhausted and you would like to dispose of it please do so in accordance with applicable legal regulations.

3.6 Downloads

Templates

Nametags

Software

2N[®] USB driver

2N[®] IP Eye

2N[®] Network Scanner

4. Technical Parameters

Signalling protocol

- SIP (UDP, TCP, TLS)

Buttons

- **Button design:** stainless-steel push buttons
- **Count of buttons:** 1, 3 or 6
- **Button extension:** up to 54 buttons
- **Numerical keypad:** optional

Audio

- **Volume control:** adjustable
- **Full duplex:** Yes (AEC)
- **Sound pressure level (SPL max):** 61.5 dB (for 1 kHz, distance 1 m)
- **Speech transmission index (STI):** 0.88

Audio stream

- **Protocols:** RTP / RTSP
- **Codecs:** G.711, G.729, G.722, L16/16kHz

Camera

- **Sensor:** 1/4" colour CMOS
- **Resolution:** 640 (H) x 480 (V)
- **Picture frequency:** Up to 30 snaps/s
- **Sensitivity:** 1.9 V/lux-sec (550 nm)
- **Viewing angle:** 55° (H), 39° (V)
- **Focal length:** 3.11 mm

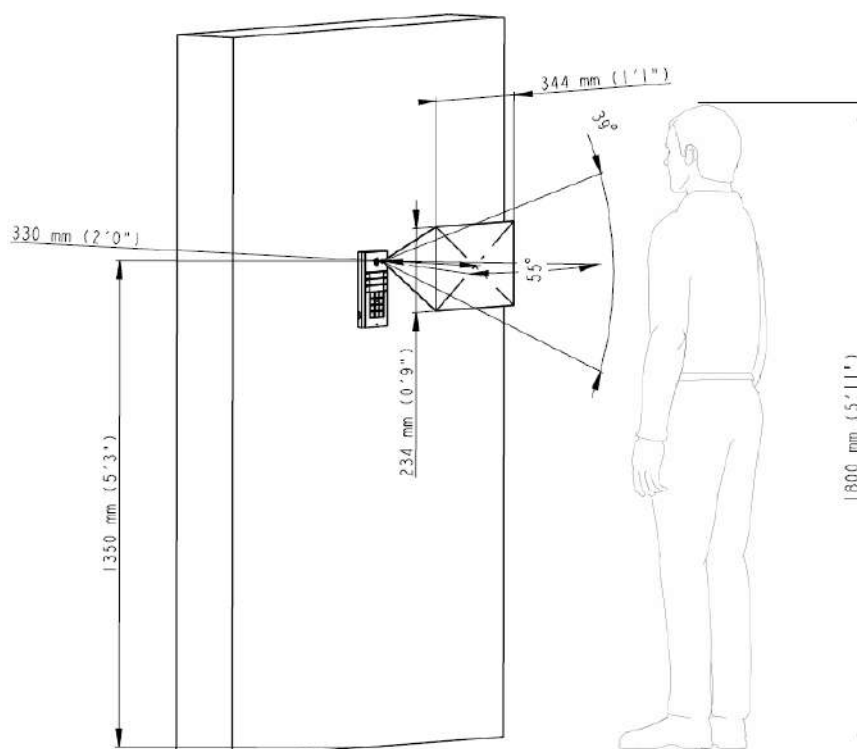

Video stream

- **Protocols:** RTP / RTSP / HTTP
- **Codecs:** H.263, H.263+, H.264, MPEG-4, M-JPEG
- **IP camera function:** Yes, ONVIF v2.4 profile S compatible

Bandwidth

- **Audio codecs**
 - PCMA, PCMU - 64 kbps (with 85.6 kbps headers)
 - G.729 - 16 kbps (with 29.6 kbps headers)
 - G.722 - 64 kbps (with 85.6 kbps headers)
 - L16 / 16 kHz - 256 kbps (with 277.6 kbps headers)

- **V i d e o c o d e c s**

Set the video codec data flows in the Services / Phone / Video menu for calls and in the Services / Streaming / RTSP menu for streaming. The set bandwidth represents the value that the codec has to approach on a long-time average. The data flows can vary depending on the scene to be scanned.

The measured data flow values correspond to the test view of a person standing in front of the intercom.

- **H.264**

- Low quality: QVGA (320 x 240), 10 fps, 256 kbps: 181 kbps (with 190 kbps headers)
- Medium quality: VGA (640 x 480), 15 fps, 768 kbps: 600 kbps (with 661 kbps headers)
- High quality: VGA (640 x 480), 30 fps, 2048 kbps: 1319 kbps (with 1372 kbps headers)

- **MJPEG**

- Low quality: QVGA (320 x 240), 10 fps, quality 70: 435 kbps with headers
- Medium quality: VGA (640 x 480), 15 fps, quality 85: 506 kbps

Interface

- **Power supply:** 12 V \pm 15 % / 2 A DC or PoE
- **PoE:** PoE 802.3af (Class 0 - 12.95 W)
- **LAN:** 10/100BASE-TX s Auto-MDIX
- **Recommended cabling:** Cat-5e or higher
- **Supported protocols:** SIP2.0, DHCP opt. 66, SMTP, 802.1x, RTSP, RTP, TFTP, HTTP, HTTPS, Syslog, ONVIF
- **Passive switch:** NO and NC contacts, up to 30 V / 1 A AC/DC
- **Active switch output:** 10 up to 14 V DC depending on power supply (PoE: approx. 14 V; adaptor: same voltage as power supply), max 600 mA

RFID card reader

- **Optional (Part No. 9137430E)**
 - Equipped with two relay outputs, two inputs and Wiegand interface
- **Supported cards 125 kHz:**
 - EM4100, EM4102

Mechanical properties

- **Working temperature:** -20 °C to 55 °C
- **Working relative humidity:** 10 % - 95 % (non-condensing)
- **Storing temperature:** -40 °C to 70 °C
- **Dimensions:** (210 x 100 x 29) mm
- **Weight:** 500 g
- **Covering level:**
 - IP53 when the roof is used (see Mounting Accessories)
 - IP50 when the roof is not used
- **Resistance level:** IK08

4.1 General drawings

Surface mounting

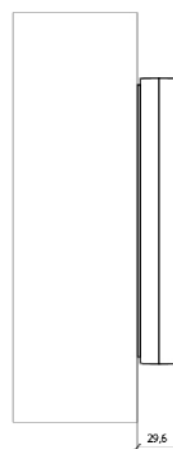
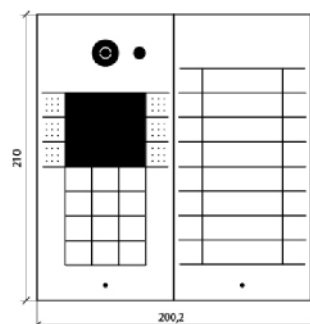
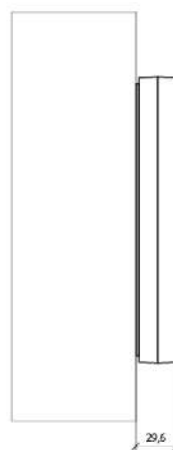
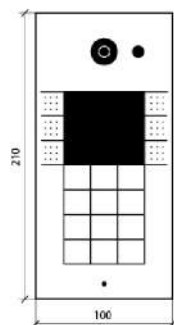

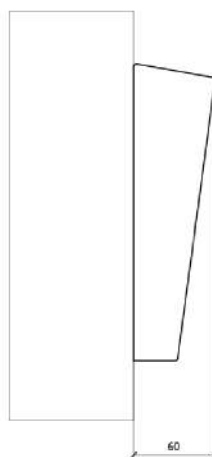
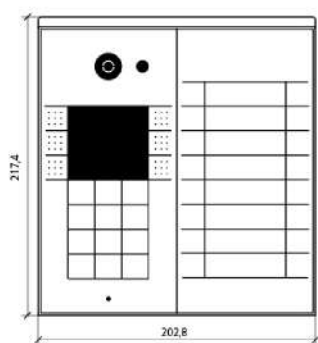
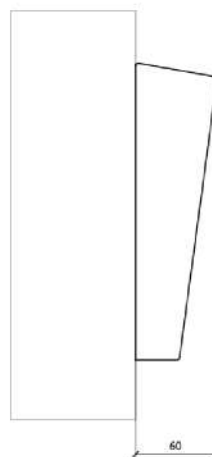
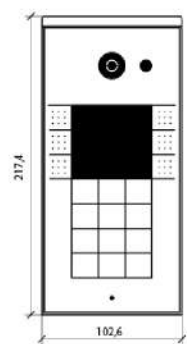

Flush mounting

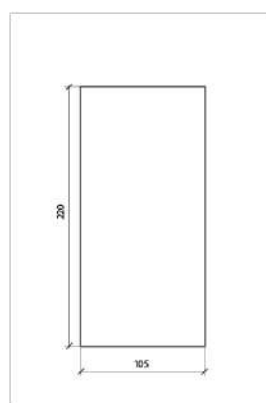
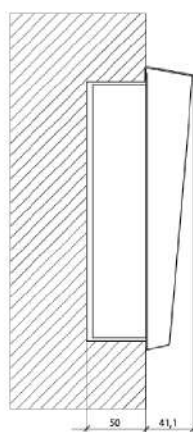
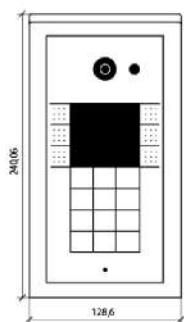

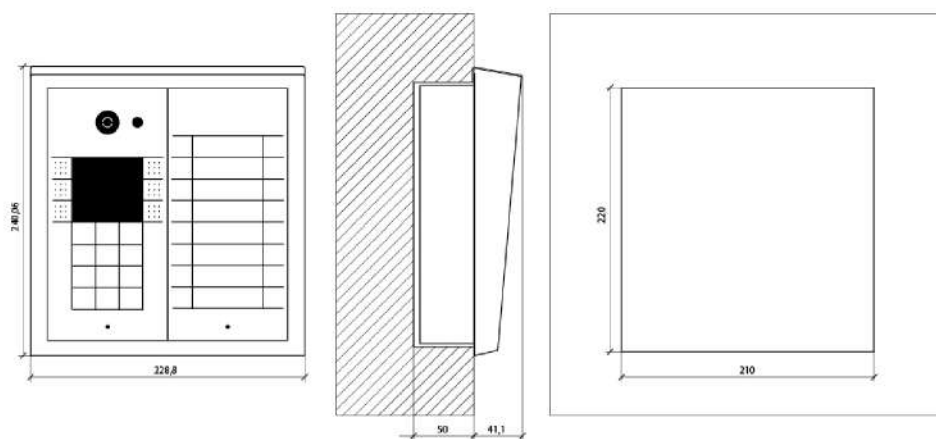

5. Supplementary Information

Here is what you can find in this section:

- 5.1 Troubleshooting
- 5.2 Directives, Laws and Regulations
- 5.3 General Instructions and Cautions

5.1 Troubleshooting



For the most frequently asked questions refer to faq.2n.cz.

5.2 Directives, Laws and Regulations

2N[®] IP Vario conforms to the following directives and regulations:

- 2014/53/EU for radio equipment
- 2011/65/EU on the restriction of the use of certain hazardous substances in electrical and electronic equipment
- 2012/19/EU on waste electrical and electronic equipment

Industry Canada

This Class B digital apparatus complies with Canadian ICES-003/NMB-003.

FCC

This equipment has been tested and found to comply with the limits for a Class B digital device, pursuant to part 15 of the FCC Rules.

NOTE: These limits are designed to provide reasonable protection against harmful interference in a residential installation. This equipment generates, uses and can radiate radio frequency energy and, if not installed and used in accordance with the instructions, may cause harmful interference to radio communications.

However, there is no guarantee that interference will not occur in a particular installation. If this equipment does cause harmful interference to radio or television reception, which can be determined by turning the equipment off and on, the user is encouraged to try to correct the interference by one or more of the following measures:

- Reorient or relocate the receiving antenna
- Increase the separation between the equipment and receiver
- Connect the equipment into an outlet on a circuit different from that to which the receiver is connected
- Consult the dealer or an experienced radio/TV technician for help

Changes or modifications to this unit not expressly approved by the party responsible for compliance could void the user's authority to operate this equipment.

DDA compliance:

2N TELEKOMUNIKACE intercoms comply with the Disability Discrimination Act 2005 (DDA) under the following conditions:

1. The intercoms are mounted so that their lower edge is between 100 and 120 centimeters above the floor.

2. The intercoms use a keyboard that has a mechanical protrusion on number 5.
3. The intercoms use electromagnetic loop as a hearing aid.

 **Caution**

Warning

In order to ensure the full functioning and guaranteed outputs we strongly recommend a verification of the timeliness of version of product or facility already during the installation process. The customer takes into consideration that the product or facility can achieve the guaranteed outputs and be fully operational pursuant to the producer's instructions only by using the most recent version of product or facility, which has been tested for full interoperability and has not been determined by the producer as incompatible with certain versions of other products, only in conformity with the producer's instructions, guidelines, manual or recommendation and only in conjunction with suitable products and facilities of the other producers. The most recent versions are available on the website https://www.2n.cz/cs_CZ/, or specific facilities, depending on their technical capacity, allow updating in the configuration interface. Should the customer use any other version of product or facility than the most recent one, or the version that has been determined by the producer as incompatible with certain versions of other producers' products of facilities, or the product or facility in a way incompatible with the producer's instructions, guidelines, manual or recommendation or in conjunction with unsuitable products or facilities of the other producers, he or she is aware of all potential limitations of functionality of such a product or facility and all relating consequences. Should the customer use any other than the most recent version of the product or facility, or the version that has been that has been determined by the producer as incompatible with certain versions of other producers' products of facilities, or the product or facility in a way incompatible with the producer's instructions, guidelines, manual or recommendation or in conjunction with unsuitable products or facilities of the other producers, he or she agrees that the company 2N TELEKOMUNIKACE a. s. is not liable neither for any limitation of such a product's functionality, nor for any damage, loss or injury relating to such a potential limitation of functionality.

5.3 General Instructions and Cautions

Please read this User Manual carefully before using the product. Follow all instructions and recommendations included herein.

Any use of the product that is in contradiction with the instructions provided herein may result in malfunction, damage or destruction of the product.

The manufacturer shall not be liable and responsible for any damage incurred as a result of a use of the product other than that included herein, namely undue application and disobedience of the recommendations and warnings in contradiction herewith.

Any use or connection of the product other than those included herein shall be considered undue and the manufacturer shall not be liable for any consequences arisen as a result of such misconduct.

Moreover, the manufacturer shall not be liable for any damage or destruction of the product incurred as a result of misplacement, incompetent installation and/or undue operation and use of the product in contradiction herewith.

The manufacturer assumes no responsibility for any malfunction, damage or destruction of the product caused by incompetent replacement of parts or due to the use of reproduction parts or components.

The manufacturer shall not be liable and responsible for any loss or damage incurred as a result of a natural disaster or any other unfavourable natural condition.

The manufacturer shall not be held liable for any damage of the product arising during the shipping thereof.

The manufacturer shall not make any warrant with regard to data loss or damage.

The manufacturer shall not be liable and responsible for any direct or indirect damage incurred as a result of a use of the product in contradiction herewith or a failure of the product due to a use in contradiction herewith.

All applicable legal regulations concerning the product installation and use as well as provisions of technical standards on electric installations have to be obeyed. The manufacturer shall not be liable and responsible for damage or destruction of the product or damage incurred by the consumer in case the product is used and handled contrary to the said regulations and provisions.

The consumer shall, at its own expense, obtain software protection of the product. The manufacturer shall not be held liable and responsible for any damage incurred as a result of the use of deficient or substandard security software.

The consumer shall, without delay, change the access password for the product after installation. The manufacturer shall not be held liable or responsible for any damage incurred by the consumer in connection with the use of the original password.

The manufacturer also assumes no responsibility for additional costs incurred by the consumer as a result of making calls using a line with an increased tariff.

Electric Waste and Used Battery Pack Handling



Do not place used electric devices and battery packs into municipal waste containers. An undue disposal thereof might impair the environment!

Deliver your expired electric appliances and battery packs removed from them to dedicated dumpsites or containers or give them back to the dealer or manufacturer for environmental-friendly disposal. The dealer or manufacturer shall take the product back free of charge and without requiring another purchase. Make sure that the devices to be disposed of are complete.

Do not throw battery packs into fire. Battery packs may not be taken into parts or short-circuited either.



2N TELEKOMUNIKACE a.s.

Modřanská 621, 143 01 Prague 4, Czech Republic

Phone: +420 261 301 500, Fax: +420 261 301 599

E-mail: sales@2n.cz

Web: www.2n.cz

v2.15